

P.C.B LAYOUT  
TOLERANCE: ±0.05

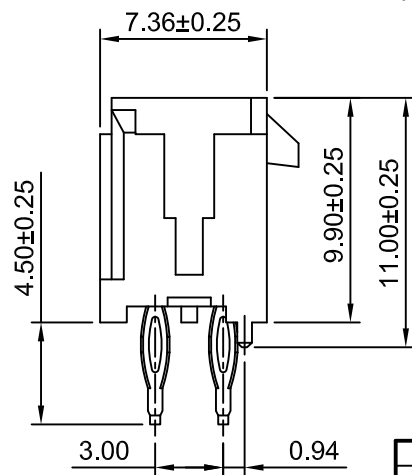
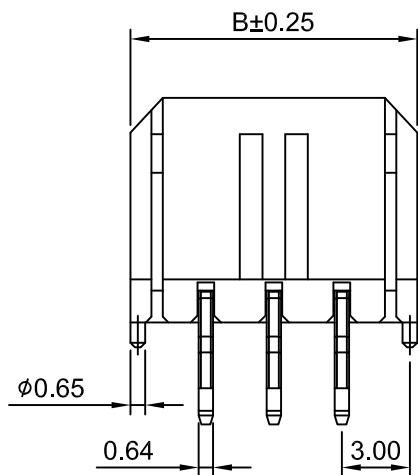

Ordering Information:  
C3030WVC-2xXP - \*\*\*  
1 2

- 1.Part NO.  
2.Pin Finish:  
(blank): Tin over Nickel  
G: Gold over Nickel(Au:1u",Mating Area)  
G15: Gold over Nickel(Au:15u",Mating Area)  
G30: Gold over Nickel(Au:30u",Mating Area)

SPECIFICATIONS:

Current Rating: 8.5A AC,DC (AWG #18)  
Voltage Rating: 250V AC,DC  
Temperature Range: -40°C ~ +105°C  
Contact Resistance: 10mΩ Max  
Insulation Resistance: 1000MΩ Min  
Withstanding Voltage: 1500V AC/minute  
Pin Material: Phosphor Bronze  
Housing Material: LCP,UL94V-0(Black)

Ordering Information & Dimensions

Part NO.	Dimensions(mm)	
	A	B
C3030WVC-2x1P	—	6.65
C3030WVC-2x2P	3.00	9.65
C3030WVC-2x3P	6.00	12.65
C3030WVC-2x4P	9.00	15.65
C3030WVC-2x5P	12.00	18.65
C3030WVC-2x6P	15.00	21.65
C3030WVC-2x7P	18.00	24.65
C3030WVC-2x8P	21.00	27.65
C3030WVC-2x9P	24.00	30.65
C3030WVC-2x10P	27.00	33.65
C3030WVC-2x11P	30.00	36.65
C3030WVC-2x12P	33.00	39.65

Beijing Hongli Kumpeng International Trade Co., Ltd.

Unit	Scale	Sheet	TITLE
mm	3:1	1 of 2	3.00mm PITCH 180° DUAL ROW WAFER
DRWN	CHK'D	APPR	
Dengchun Yi	Diankui Wan	Jack Yin	DRAWING NO.
General Tolerances			THIRD ANGLE PROJECTION
A2	ADD THE SHEET 2	2020.08.19	HLB-30-WVC-2xXP 9
A1	CHANGE THE CURRENT RATING	2018.12.26	
A0	NEW RELEASE	2013.02.27	
REV	DESCRIPTION	DATE	

REV A2

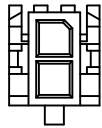

2x1P

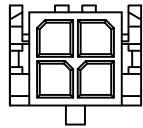

2x2P

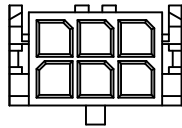

2x3P

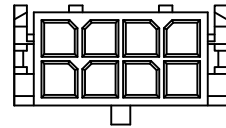

2x4P

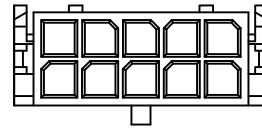

2x5P

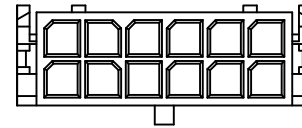

2x6P

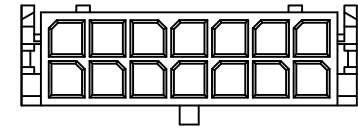

2x7P

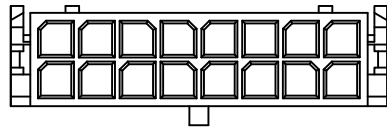

2x8P

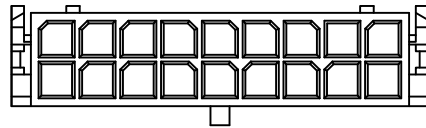

2x9P

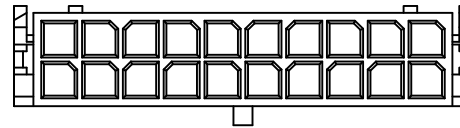

2x10P

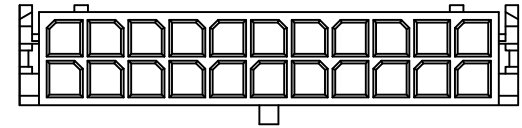

2x11P

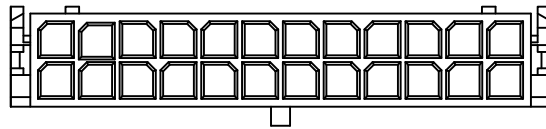

2x12P

Beijing Hongli Kunpeng International Trade Co., Ltd.

Unit	Scale	Sheet	TITLE
mm	3:1	2 of 2	
DRWN	CHK'D	APPR	3.00mm PITCH 180° DUAL ROW WAFER
Dengchun Yi	Diankui Wan	Jack Yin	
General Tolerances			DRAWING NO.
THIRD ANGLE PROJECTION			
x.xx±0.25 x.xxx±0.20 x.xxxx±0.15 ANGLES ±1°			HLB-30-WVC-2xXP 9
REV	DESCRIPTION	DATE	REV A2

A2	ADD THE SHEET 2	2020.08.19
A1	CHANGE THE CURRENT RATING	2018.12.26
A0	NEW RELEASE	2013.02.27
REV	DESCRIPTION	DATE