

RECOMMENDED P.C.B LAYOUT TOP VIEW
(COMPONENT SIDE DIM' ±0.05)

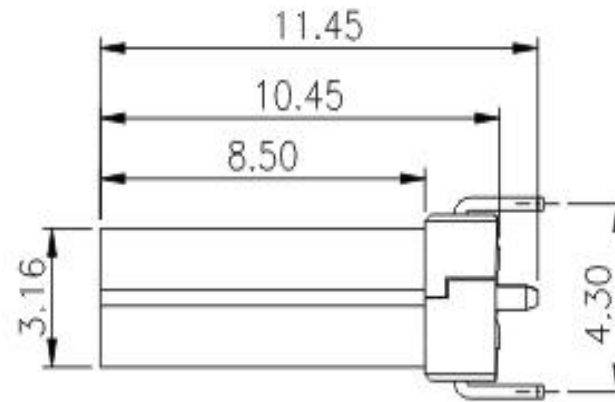
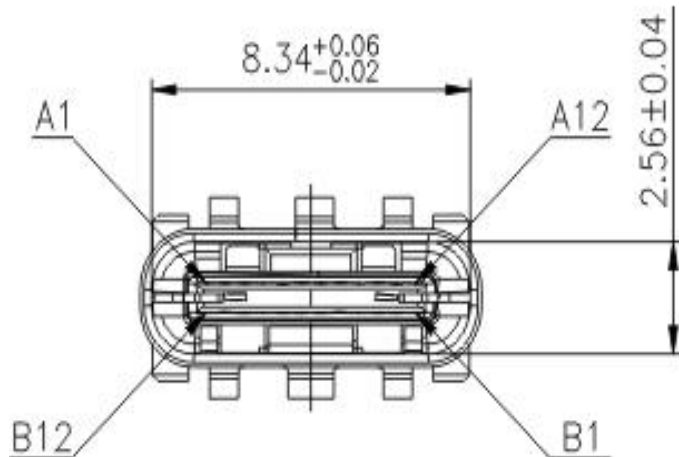

TYPE-C Female SMT 180 ° 24P(H=10.45)

Current Rating : 3.0 Ampere

Insulation Resistance : 100 M Min

Dielectric Withstanding : 100 V

Contact Resistance : 40 m Max

Mating Force : 5~20N

Unmating Force: 8~20N

Durability : 10000 Cycles