

**DELIVERY SPECIFICATION**

SPEC. No. C-General-m

D A T E : Dec., 2021

To

**Non-Controlled Copy**

CUSTOMER'S PRODUCT NAME

TDK'S PRODUCT NAME

Multilayer Ceramic Chip Capacitors  
 Bulk and tape packaging 【RoHS compliant】  
 C0603,C1005,C1608,C2012,C3216,C3225,  
 C4532,C5750 Type  
 C0G, X5R,X6S,X7R,X7S,X7T Characteristics

Please return this specification to TDK representatives with your signature.  
 If orders are placed without returned specification, please allow us to judge that specification is accepted by your side.

**RECEIPT CONFIRMATION**

DATE: \_\_\_\_\_ YEAR \_\_\_\_\_ MONTH \_\_\_\_\_ DAY \_\_\_\_\_

TDK Corporation  
 Sales  
 Electronic Components  
 Sales & Marketing Group

Engineering  
 Electronic Components Business Company  
 Ceramic Capacitors Business Group

APPROVED	Person in charge

APPROVED	CHECKED	Person in charge

**SCOPE**

This delivery specification shall be applied to Multilayer ceramic chip capacitors to be delivered to \_\_\_\_\_.

**PRODUCTION PLACES**

Production places defined in this specification shall be TDK Corporation, TDK(Suzhou)Co.,Ltd and TDK Components U.S.A.,Inc.

**PRODUCT NAME**

The name of the product to be defined in this specifications shall be C◇◇◇◇○○○△△□□□×.

**REFERENCE STANDARD**

- JIS C 5101-1 : 2010 Fixed capacitors for use in electronic equipment-Part 1: Generic specification  
 C 5101-21 : 2014 Fixed capacitors for use in electronic equipment-Part 21 : Sectional specification : Fixed surface mount multilayer capacitors of ceramic dielectric,Class1  
 C 5101-22 : 2014 Fixed capacitors for use in electronic equipment-Part 22 : Sectional specification : Fixed surface mount multilayer capacitors of ceramic dielectric,Class2  
 C 0806-3 : 2014 Packaging of components for automatic handling - Part 3: Packaging of surface mount components on continuous tapes  
 JEITA RCR-2335 C 2014 Safety application guide for fixed ceramic capacitors for use in electronic equipment

**CONTENTS**

1. CODE CONSTRUCTION
2. COMBINATION OF RATED CAPACITANCE AND TOLERANCE
3. OPERATING TEMPERATURE RANGE
4. STORING CONDITION AND TERM
5. P.C. BOARD
6. INDUSTRIAL WASTE DISPOSAL
7. PERFORMANCE
8. INSIDE STRUCTURE AND MATERIAL
9. PACKAGING
10. RECOMMENDATION
11. SOLDERING CONDITION
12. CAUTION
13. TAPE PACKAGING SPECIFICATION

**<EXPLANATORY NOTE>**

When the mistrust in the spec arises, this specification is given priority. And it will be confirmed by written spec change after conference of both posts involved.

This specification warrants the quality of the ceramic chip capacitor. Capacitors should be evaluated or confirmed a state of mounted on your product.

If the use of the capacitors goes beyond the bounds of this specification, we can not afford to guarantee.

Division	Date	SPEC. No.
Ceramic Capacitors Business Group	December, 2021	C-General-m

## 1. CODE CONSTRUCTION

(Example) C2012 X7R 1E 225 K T 0000  
 (1) (2) (3) (4) (5) (6) (7)

(1) Case size

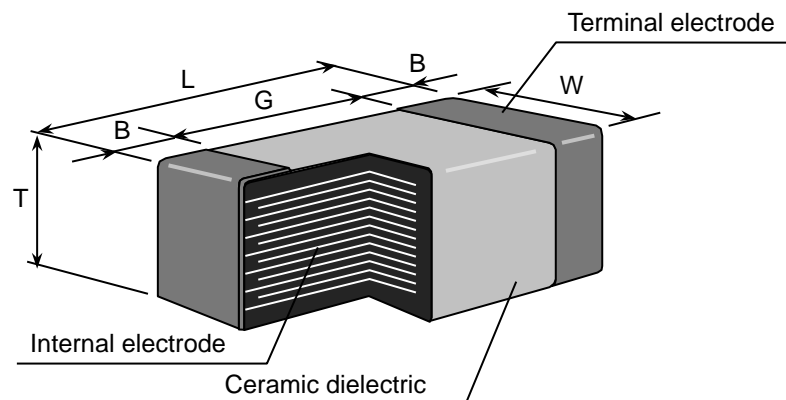

Case size [EIA style]	Dimensions (mm)				
	L	W	T	B	G
C0603 [CC0201]	0.60±0.03	0.30±0.03	0.30±0.03	0.10 min.	0.20 min.
	0.60±0.05	0.30±0.05	0.30±0.05		
C1005 [CC0402]	1.00±0.05	0.50±0.05	0.50±0.05	0.10 min.	0.30 min.
	1.00±0.10	0.50±0.10	0.50±0.10		
	1.00 <sup>+0.15</sup> <sub>-0.10</sub>	0.50 <sup>+0.15</sup> <sub>-0.10</sub>	0.50 <sup>+0.15</sup> <sub>-0.10</sub>		
C1608 [CC0603]	1.60±0.10	0.80±0.10	0.80±0.10	0.20 min.	0.30 min.
	1.60 <sup>+0.15</sup> <sub>-0.10</sub>	0.80 <sup>+0.15</sup> <sub>-0.10</sub>	0.80 <sup>+0.15</sup> <sub>-0.10</sub>		
	1.60±0.20	0.80±0.20	0.80±0.20		
C2012 [CC0805]	2.00±0.20	1.25±0.20	0.60±0.15	0.20 min.	0.50 min.
			0.85±0.15		
			1.25±0.20		
			1.25 <sup>+0.25</sup> <sub>-0.15</sub>		
C3216 [CC1206]	3.20±0.20	1.60±0.20	0.60±0.15	0.20 min.	1.00 min.
			0.85±0.15		
			1.15±0.15		
			1.30±0.20		
			1.60±0.20		
3.20 <sup>+0.30</sup> <sub>-0.10</sub>	1.60 <sup>+0.30</sup> <sub>-0.10</sub>	1.60 <sup>+0.30</sup> <sub>-0.10</sub>			
C3225 [CC1210]	3.20±0.40	2.50±0.30	1.25±0.20	0.20 min.	—
			1.60±0.20		
			2.00±0.20		
			2.30±0.20		
			2.50±0.30		
			3.20 <sup>+0.45</sup> <sub>-0.40</sub>		
3.20±0.40	2.50 <sup>+0.40</sup> <sub>-0.30</sub>	2.50 <sup>+0.40</sup> <sub>-0.30</sub>			
C4532 [CC1812]	4.50±0.40	3.20±0.40	1.60±0.20	0.20 min.	—
			2.00±0.20		
			2.30±0.20		
			2.50±0.30		
			2.80±0.30		
			3.20±0.30		

\* As for each item, please refer to detail page on TDK web.

Case size [EIA style]	Dimensions (mm)				
	L	W	T	B	G
C5750 [CC2220]	5.70±0.40	5.00±0.40	1.60±0.20	0.20 min.	—
			2.00±0.20		
			2.30±0.20		
			2.50±0.30		
			2.80±0.30		

\* As for each item, please refer to detail page on TDK web.

(2) Temperature Characteristics

\* Details are shown in table 1 No.6 and No.7 at 7.PERFORMANCE

(3) Rated Voltage

Symbol	Rated Voltage	Symbol	Rated Voltage
2 J	DC 630 V	1 V	DC 35 V
2 W	DC 450 V	1 E	DC 25 V
2 V	DC 350 V	1 C	DC 16 V
2 E	DC 250 V	1 A	DC 10 V
2 A	DC 100 V	0 J	DC 6.3 V
1 N	DC 75 V	0 G	DC 4 V
1 H	DC 50 V		

(4) Rated Capacitance

Stated in three digits and in units of pico farads (pF).  
The first and Second digits identify the first and second significant figures of the capacitance, the third digit identifies the multiplier.  
R is designated for a decimal point.

(Example)

Symbol	Rated Capacitance
2R2	2.2 pF
225	2,200,000 pF

(5) Capacitance tolerance

\* M tolerance shall be standard for over 10uF.

Symbol	Tolerance	Capacitance
C	± 0.25 pF	10pF and under
D	± 0.5 pF	
J	± 5 %	Over 10pF
K	± 10 %	
* M	± 20 %	

(6) Packaging

\* C0603,C1005 type is applicable to tape packaging only.

Symbol	Packaging
B	Bulk
T	Taping

(7) TDK internal code

## 2. COMBINATION OF RATED CAPACITANCE AND TOLERANCE

Class	Temperature Characteristics	Capacitance tolerance		Rated capacitance
1	C0G	10pF and under	C ( $\pm 0.25\text{pF}$ )	1, 2, 3, 4, 5
			D ( $\pm 0.5\text{pF}$ )	6, 7, 8, 9, 10
		Over 10pF	J ( $\pm 5\%$ )	E – 6 series
2	X5R X6S X7R X7S X7T	10uF and under	K ( $\pm 10\%$ ) M ( $\pm 20\%$ )	E – 6 series
		Over 10uF	M ( $\pm 20\%$ )	

### Capacitance Step in E series

E series	Capacitance Step					
E- 6	1.0	1.5	2.2	3.3	4.7	6.8

## 3. OPERATING TEMPERATURE RANGE

T.C.	Min. operating Temperature	Max. operating Temperature	Reference Temperature
X5R	-55°C	85°C	25°C
X6S	-55°C	105°C	25°C
C0G/X7R/X7S/X7T	-55°C	125°C	25°C

## 4. STORING CONDITION AND TERM

Storing temperature	Storing humidity	Storing term
5~40°C	20~70%RH	Within 6 months upon receipt.

## 5. P.C. BOARD

When mounting on an aluminum substrate, the capacitors are more likely to be affected by heat stress from the substrate.

Please inquire separate specification when mounted on the substrate.

## 6. INDUSTRIAL WASTE DISPOSAL

Dispose this product as industrial waste in accordance with the Industrial Waste Law.

## 7. PERFORMANCE

table 1

No.	Item		Performance	Test or inspection method																							
1	External Appearance		No defects which may affect performance.	Inspect with magnifying glass (3×), in case of C0603 type, with magnifying glass (10×)																							
2	Insulation Resistance		Please refer to detail page on TDK web.	Measuring voltage : Rated voltage (As for the capacitor of rated voltage 630V DC, apply 500V DC.) Voltage application time : 60s.																							
3	Voltage Proof		Withstand test voltage without insulation breakdown or other damage.	<table border="1"> <thead> <tr> <th>Class</th> <th>Rated voltage(RV)</th> <th>Apply voltage</th> </tr> </thead> <tbody> <tr> <td rowspan="3">1</td> <td><math>RV \leq 100V</math></td> <td>3 × rated voltage</td> </tr> <tr> <td><math>100V &lt; RV \leq 500V</math></td> <td>1.5 × rated voltage</td> </tr> <tr> <td><math>500V &lt; RV</math></td> <td>1.3 × rated voltage</td> </tr> <tr> <td rowspan="4">2</td> <td><math>RV \leq 100V</math></td> <td>2.5 × rated voltage</td> </tr> <tr> <td>C3225X7R2A106K</td> <td>2 × rated voltage</td> </tr> <tr> <td><math>100V &lt; RV \leq 500V</math></td> <td>1.5 × rated voltage</td> </tr> <tr> <td><math>500V &lt; RV</math></td> <td>1.3 × rated voltage</td> </tr> <tr> <td colspan="2"></td> <td>C2012X5R2A475K C3216X6S2A106K</td> <td>1.25 × rated voltage</td> </tr> </tbody> </table> <p>Voltage application time : 1s. Charge / discharge current : 50mA or lower</p>	Class	Rated voltage(RV)	Apply voltage	1	$RV \leq 100V$	3 × rated voltage	$100V < RV \leq 500V$	1.5 × rated voltage	$500V < RV$	1.3 × rated voltage	2	$RV \leq 100V$	2.5 × rated voltage	C3225X7R2A106K	2 × rated voltage	$100V < RV \leq 500V$	1.5 × rated voltage	$500V < RV$	1.3 × rated voltage			C2012X5R2A475K C3216X6S2A106K	1.25 × rated voltage
Class	Rated voltage(RV)	Apply voltage																									
1	$RV \leq 100V$	3 × rated voltage																									
	$100V < RV \leq 500V$	1.5 × rated voltage																									
	$500V < RV$	1.3 × rated voltage																									
2	$RV \leq 100V$	2.5 × rated voltage																									
	C3225X7R2A106K	2 × rated voltage																									
	$100V < RV \leq 500V$	1.5 × rated voltage																									
	$500V < RV$	1.3 × rated voltage																									
		C2012X5R2A475K C3216X6S2A106K	1.25 × rated voltage																								
4	Capacitance		Within the specified tolerance.	As for measuring condition, please contact with our sales representative.																							
5	Q	Class1	Please refer to detail page on TDK web.	See No.4 in this table for measuring condition.																							
	Dissipation Factor	Class2																									

(continued)

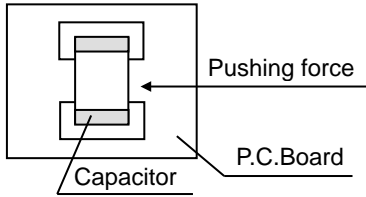
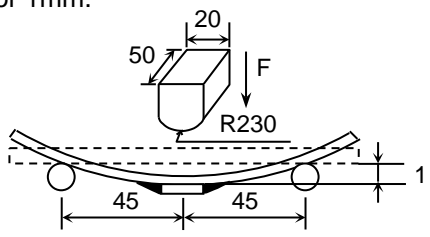
No.	Item	Performance	Test or inspection method																										
6	Temperature Characteristics of Capacitance (Class1)	<table border="1"> <tr> <td>T.C.</td> <td>Temperature Coefficient (ppm/°C)</td> </tr> <tr> <td>C0G</td> <td>0 ± 30</td> </tr> <tr> <td>Capacitance drift</td> <td>Within ± 0.2% or ± 0.05pF, whichever larger.</td> </tr> </table>	T.C.	Temperature Coefficient (ppm/°C)	C0G	0 ± 30	Capacitance drift	Within ± 0.2% or ± 0.05pF, whichever larger.	<p>Temperature coefficient shall be calculated based on values at 25°C and 85°C temperature.</p> <p>Measuring temperature below 25°C shall be -10°C and -25°C.</p>																				
T.C.	Temperature Coefficient (ppm/°C)																												
C0G	0 ± 30																												
Capacitance drift	Within ± 0.2% or ± 0.05pF, whichever larger.																												
7	Temperature Characteristics of Capacitance (Class2)	<table border="1"> <tr> <th colspan="2">Capacitance Change (%)</th> </tr> <tr> <th colspan="2">No voltage applied</th> </tr> <tr> <td>X5R :</td> <td>±15</td> </tr> <tr> <td>X6S :</td> <td>±22</td> </tr> <tr> <td>X7R :</td> <td>±15</td> </tr> <tr> <td>X7S :</td> <td>±22</td> </tr> <tr> <td>X7T :</td> <td>+22</td> </tr> <tr> <td></td> <td>- 33</td> </tr> </table>	Capacitance Change (%)		No voltage applied		X5R :	±15	X6S :	±22	X7R :	±15	X7S :	±22	X7T :	+22		- 33	<p>Capacitance shall be measured by the steps shown in the following table after thermal equilibrium is obtained for each step.</p> <p>ΔC be calculated ref. STEP3 reading</p> <table border="1"> <thead> <tr> <th>Step</th> <th>Temperature(°C)</th> </tr> </thead> <tbody> <tr> <td>1</td> <td>Reference temp. ± 2</td> </tr> <tr> <td>2</td> <td>Min. operating temp. ± 2</td> </tr> <tr> <td>3</td> <td>Reference temp. ± 2</td> </tr> <tr> <td>4</td> <td>Max. operating temp. ± 2</td> </tr> </tbody> </table> <p>As for Min./Max. operating temp and Reference temp., please refer to "3. OPERATING TEMPERATURE RANGE" As for measuring voltage, please contact with our sales representative.</p>	Step	Temperature(°C)	1	Reference temp. ± 2	2	Min. operating temp. ± 2	3	Reference temp. ± 2	4	Max. operating temp. ± 2
Capacitance Change (%)																													
No voltage applied																													
X5R :	±15																												
X6S :	±22																												
X7R :	±15																												
X7S :	±22																												
X7T :	+22																												
	- 33																												
Step	Temperature(°C)																												
1	Reference temp. ± 2																												
2	Min. operating temp. ± 2																												
3	Reference temp. ± 2																												
4	Max. operating temp. ± 2																												
8	Robustness of Terminations	No sign of termination coming off, breakage of ceramic, or other abnormal signs.	<p>Reflow solder the capacitors on a P.C.Board shown in Appendix 2.</p> <p>Apply a pushing force gradually at the center of a specimen in a horizontal direction of P.C.board.</p> <p>Pushing force : 5N (2N is applied for C0603,C1005 type.) Holding time : 10±1s</p> 																										
9	Bending External appearance	No mechanical damage.	<p>Reflow solder the capacitors on a P.C.Board shown in Appendix1 and bend it for 1mm.</p>  <p>(Unit : mm)</p>																										

(continued)

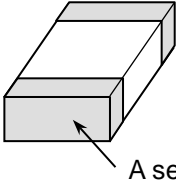
No.	Item	Performance	Test or inspection method																					
10	Solderability	<p>New solder to cover over 75% of termination. 25% may have pin holes or rough spots but not concentrated in one spot. Ceramic surface of A sections shall not be exposed due to melting or shifting of termination material.</p>  <p style="text-align: center;">A section</p>	<p>Solder : Sn-3.0Ag-0.5Cu</p> <p>Flux : Isopropyl alcohol (JIS K 8839) Rosin (JIS K 5902) 25% solid solution.</p> <p>Solder temp. : 245±5°C</p> <p>Dwell time : 3±0.3s.</p> <p>Solder position : Until both terminations are completely soaked.</p>																					
11	Resistance to solder heat	<table border="1"> <tr> <td>External appearance</td> <td>No cracks are allowed and terminations shall be covered at least 60% with new solder.</td> </tr> <tr> <td>Capacitance</td> <td> <table border="1"> <thead> <tr> <th colspan="2">Characteristics</th> <th>Change from the value before test</th> </tr> </thead> <tbody> <tr> <td>Class 1</td> <td>C0G</td> <td>Capacitance drift within ±2.5% or ±0.25pF, whichever larger.</td> </tr> <tr> <td>Class 2</td> <td>X5R X6S X7R X7S X7T</td> <td>± 7.5 %</td> </tr> </tbody> </table> </td> </tr> <tr> <td>Q (Class1)</td> <td>Meet the initial spec.</td> </tr> <tr> <td>D.F. (Class2)</td> <td>Meet the initial spec.</td> </tr> <tr> <td>Insulation Resistance</td> <td>Meet the initial spec.</td> </tr> <tr> <td>Voltage proof</td> <td>No insulation breakdown or other damage.</td> </tr> </table>	External appearance	No cracks are allowed and terminations shall be covered at least 60% with new solder.	Capacitance	<table border="1"> <thead> <tr> <th colspan="2">Characteristics</th> <th>Change from the value before test</th> </tr> </thead> <tbody> <tr> <td>Class 1</td> <td>C0G</td> <td>Capacitance drift within ±2.5% or ±0.25pF, whichever larger.</td> </tr> <tr> <td>Class 2</td> <td>X5R X6S X7R X7S X7T</td> <td>± 7.5 %</td> </tr> </tbody> </table>	Characteristics		Change from the value before test	Class 1	C0G	Capacitance drift within ±2.5% or ±0.25pF, whichever larger.	Class 2	X5R X6S X7R X7S X7T	± 7.5 %	Q (Class1)	Meet the initial spec.	D.F. (Class2)	Meet the initial spec.	Insulation Resistance	Meet the initial spec.	Voltage proof	No insulation breakdown or other damage.	<p>Solder : Sn-3.0Ag-0.5Cu</p> <p>Flux : Isopropyl alcohol (JIS K 8839) Rosin (JIS K 5902) 25% solid solution.</p> <p>Solder temp. : 260±5°C</p> <p>Dwell time : 10±1s.</p> <p>Solder position : Until both terminations are completely soaked.</p> <p>Pre-heating : Temp. — 110~140°C Time — 30~60s.</p> <p>Leave the capacitors in ambient condition for Class 1 : 6~24h Class 2 : 24±2h before measurement.</p>
External appearance	No cracks are allowed and terminations shall be covered at least 60% with new solder.																							
Capacitance	<table border="1"> <thead> <tr> <th colspan="2">Characteristics</th> <th>Change from the value before test</th> </tr> </thead> <tbody> <tr> <td>Class 1</td> <td>C0G</td> <td>Capacitance drift within ±2.5% or ±0.25pF, whichever larger.</td> </tr> <tr> <td>Class 2</td> <td>X5R X6S X7R X7S X7T</td> <td>± 7.5 %</td> </tr> </tbody> </table>	Characteristics		Change from the value before test	Class 1	C0G	Capacitance drift within ±2.5% or ±0.25pF, whichever larger.	Class 2	X5R X6S X7R X7S X7T	± 7.5 %														
Characteristics		Change from the value before test																						
Class 1	C0G	Capacitance drift within ±2.5% or ±0.25pF, whichever larger.																						
Class 2	X5R X6S X7R X7S X7T	± 7.5 %																						
Q (Class1)	Meet the initial spec.																							
D.F. (Class2)	Meet the initial spec.																							
Insulation Resistance	Meet the initial spec.																							
Voltage proof	No insulation breakdown or other damage.																							



(continued)

No.	Item		Performance	Test or inspection method															
12	Vibration	External appearance	No mechanical damage.	Frequency : 10~55~10Hz Reciprocating sweep time : 1 min. Amplitude : 1.5mm Repeat this for 2h each in 3 perpendicular directions(Total 6h).  Reflow solder the capacitors on a P.C.Board shown in Appendix 2 before testing.															
		Capacitance	Characteristics		Change from the value before test														
			Class1		C0G	Capacitance drift within $\pm 2.5\%$ or $\pm 0.25\text{pF}$ , whichever larger.													
			Class2		X5R X6S X7R X7S X7T	$\pm 7.5\%$													
		Q (Class1)	Meet the initial spec.																
D.F. (Class2)	Meet the initial spec.																		
13	Temperature cycle	External appearance	No mechanical damage.	Expose the capacitors in the condition step1 through step 4 listed in the following table.  Temp. cycle : 5 cycles <table border="1" data-bbox="986 1077 1477 1413"> <thead> <tr> <th>Step</th> <th>Temperature(°C)</th> <th>Time (min.)</th> </tr> </thead> <tbody> <tr> <td>1</td> <td>Min. operating temp.<math>\pm 3</math></td> <td>30 <math>\pm</math> 3</td> </tr> <tr> <td>2</td> <td>Ambient Temp.</td> <td>2 ~ 5</td> </tr> <tr> <td>3</td> <td>Max. operating temp.<math>\pm 2</math></td> <td>30 <math>\pm</math> 2</td> </tr> <tr> <td>4</td> <td>Ambient Temp.</td> <td>2 ~ 5</td> </tr> </tbody> </table> As for Min./Max. operating temp., please refer to "3. OPERATING TEMPERATURE RANGE"  Leave the capacitors in ambient condition for Class 1 : 6~24h Class 2 : 24 $\pm$ 2h before measurement.  Reflow solder the capacitors on a P.C.Board shown in Appendix2 before testing.	Step	Temperature(°C)	Time (min.)	1	Min. operating temp. $\pm 3$	30 $\pm$ 3	2	Ambient Temp.	2 ~ 5	3	Max. operating temp. $\pm 2$	30 $\pm$ 2	4	Ambient Temp.	2 ~ 5
		Step	Temperature(°C)		Time (min.)														
		1	Min. operating temp. $\pm 3$		30 $\pm$ 3														
		2	Ambient Temp.		2 ~ 5														
		3	Max. operating temp. $\pm 2$		30 $\pm$ 2														
		4	Ambient Temp.		2 ~ 5														
		Capacitance	Characteristics		Change from the value before test														
Class1	C0G		Please contact with our sales representative.																
Class2	X5R X6S X7R X7S X7T																		
Q (Class1)	Meet the initial spec.																		
D.F. (Class2)	Meet the initial spec.																		
Insulation Resistance	Meet the initial spec.																		
Voltage proof	No insulation breakdown or other damage.																		

(continued)

No.	Item		Performance	Test or inspection method													
14	Moisture Resistance (Steady State)	External appearance	No mechanical damage.	Test temp. : 40±2°C Test humidity : 90~95%RH Test time : 500 +24,0h Leave the capacitors in ambient condition for Class 1 : 6~24h Class 2 : 24±2h before measurement.  Reflow solder the capacitors on a P.C.Board shown in Appendix2 before testing.													
		Capacitance	<table border="1"> <thead> <tr> <th colspan="2">Characteristics</th> <th rowspan="2">Change from the value before test</th> </tr> <tr> <th>Class1</th> <th>C0G</th> </tr> </thead> <tbody> <tr> <td rowspan="4">Class2</td> <td>X5R</td> <td rowspan="4">Please contact with our sales representative.</td> </tr> <tr> <td>X6S</td> </tr> <tr> <td>X7R</td> </tr> <tr> <td>X7S</td> </tr> <tr> <td>X7T</td> <td></td> </tr> </tbody> </table>		Characteristics		Change from the value before test	Class1	C0G	Class2	X5R	Please contact with our sales representative.	X6S	X7R	X7S	X7T	
			Characteristics		Change from the value before test												
			Class1			C0G											
		Class2	X5R		Please contact with our sales representative.												
X6S																	
X7R																	
X7S																	
X7T																	
Q (Class1)	<table border="1"> <thead> <tr> <th>Capacitance</th> <th>Q</th> </tr> </thead> <tbody> <tr> <td>30pF and over</td> <td>350 min.</td> </tr> <tr> <td>10pF and over under 30pF</td> <td>275+5/2×C min.</td> </tr> <tr> <td>Under 10pF</td> <td>200+10×C min.</td> </tr> </tbody> </table> C : Rated capacitance (pF)	Capacitance	Q	30pF and over	350 min.	10pF and over under 30pF	275+5/2×C min.	Under 10pF	200+10×C min.								
	Capacitance	Q															
	30pF and over	350 min.															
10pF and over under 30pF	275+5/2×C min.																
Under 10pF	200+10×C min.																
D.F. (Class2)	200% of initial spec. max.																
Insulation Resistance	Please contact with our sales representative.																

(continued)

No.	Item		Performance	Test or inspection method												
15	Moisture Resistance	External appearance	No mechanical damage.	Test temp. : $40\pm 2^{\circ}\text{C}$ Test humidity : 90~95%RH Applied voltage : Rated voltage Test time : 500 +24,0h Charge/discharge current : 50mA or lower Leave the capacitors in ambient condition for Class 1 : 6~24h Class 2 : $24\pm 2$ h before measurement.  Reflow solder the capacitors on a P.C.Board shown in Appendix2 before testing.  Initial value setting (only for class 2) Voltage conditioning «After voltage treat the capacitors under testing temperature and voltage for 1 hour,» leave the capacitors in ambient condition for $24\pm 2$ h before measurement. Use this measurement for initial value.												
		Capacitance	<table border="1"> <thead> <tr> <th colspan="2">Characteristics</th> <th>Change from the value before test</th> </tr> </thead> <tbody> <tr> <td>Class1</td> <td>C0G</td> <td rowspan="5">Please contact with our sales representative.</td> </tr> <tr> <td rowspan="4">Class2</td> <td>X5R</td> </tr> <tr> <td>X6S</td> </tr> <tr> <td>X7R</td> </tr> <tr> <td>X7S</td> </tr> <tr> <td>X7T</td> </tr> </tbody> </table>		Characteristics		Change from the value before test	Class1	C0G	Please contact with our sales representative.	Class2	X5R	X6S	X7R	X7S	X7T
			Characteristics		Change from the value before test											
			Class1		C0G	Please contact with our sales representative.										
		Class2	X5R													
X6S																
X7R																
X7S																
X7T																
Q (Class1)	<table border="1"> <thead> <tr> <th>Capacitance</th> <th>Q</th> </tr> </thead> <tbody> <tr> <td>30pF and over</td> <td>200 min.</td> </tr> <tr> <td>Under 30pF</td> <td><math>100+10/3\times C</math> min.</td> </tr> </tbody> </table>	Capacitance	Q	30pF and over	200 min.	Under 30pF	$100+10/3\times C$ min.									
	Capacitance	Q														
30pF and over	200 min.															
Under 30pF	$100+10/3\times C$ min.															
D.F. (Class2)	200% of initial spec. max.															
Insulation Resistance	Please contact with our sales representative.															

(continued)

No.	Item	Performance	Test or inspection method											
16	Life													
	External appearance	No mechanical damage.	Test temp. : Maximum operating temperature $\pm 2^{\circ}\text{C}$ Applied voltage : Please contact with our sales representative.											
	Capacitance	<table border="1"> <thead> <tr> <th colspan="2">Characteristics</th> <th rowspan="2">Change from the value before test</th> </tr> <tr> <th>Class1</th> <th>C0G</th> </tr> </thead> <tbody> <tr> <td rowspan="4">Class2</td> <td>X5R</td> <td rowspan="4">Please contact with our sales representative.</td> </tr> <tr> <td>X6S</td> </tr> <tr> <td>X7R</td> </tr> <tr> <td>X7S X7T</td> </tr> </tbody> </table>	Characteristics		Change from the value before test	Class1	C0G	Class2	X5R	Please contact with our sales representative.	X6S	X7R	X7S X7T	Test time : 1,000 +48,0h Charge/discharge current : 50mA or lower Leave the capacitors in ambient condition for Class 1 : 6~24h Class 2 : 24 $\pm$ 2h before measurement.
	Characteristics		Change from the value before test											
	Class1	C0G												
Class2	X5R	Please contact with our sales representative.												
	X6S													
	X7R													
	X7S X7T													
Q (Class1)	<table border="1"> <thead> <tr> <th>Capacitance</th> <th>Q</th> </tr> </thead> <tbody> <tr> <td>30pF and over</td> <td>350 min.</td> </tr> <tr> <td>10pF and over under 30pF</td> <td>275+5/2<math>\times</math>C min.</td> </tr> <tr> <td>Under 10pF</td> <td>200+10<math>\times</math>C min.</td> </tr> </tbody> </table> <p>C : Rated capacitance (pF)</p>	Capacitance	Q	30pF and over	350 min.	10pF and over under 30pF	275+5/2 $\times$ C min.	Under 10pF	200+10 $\times$ C min.	Reflow solder the capacitors on a P.C.Board shown in Appendix2 before testing.  Initial value setting (only for class 2) Voltage conditioning «After voltage treat the capacitors under testing temperature and voltage for 1 hour,» leave the capacitors in ambient condition for 24 $\pm$ 2h before measurement.				
Capacitance	Q													
30pF and over	350 min.													
10pF and over under 30pF	275+5/2 $\times$ C min.													
Under 10pF	200+10 $\times$ C min.													
D.F. (Class2)	200% of initial spec. max.	Use this measurement for initial value.												
	Insulation Resistance	Please contact with our sales representative.												

\*As for the initial measurement of capacitors (Class2) on number 7,11,12,13 and 14, leave capacitors at 150 0,-10 $^{\circ}\text{C}$  for 1 hour and measure the value after leaving capacitors for 24  $\pm$  2h in ambient condition.

### Appendix1 P.C.Board for bending test

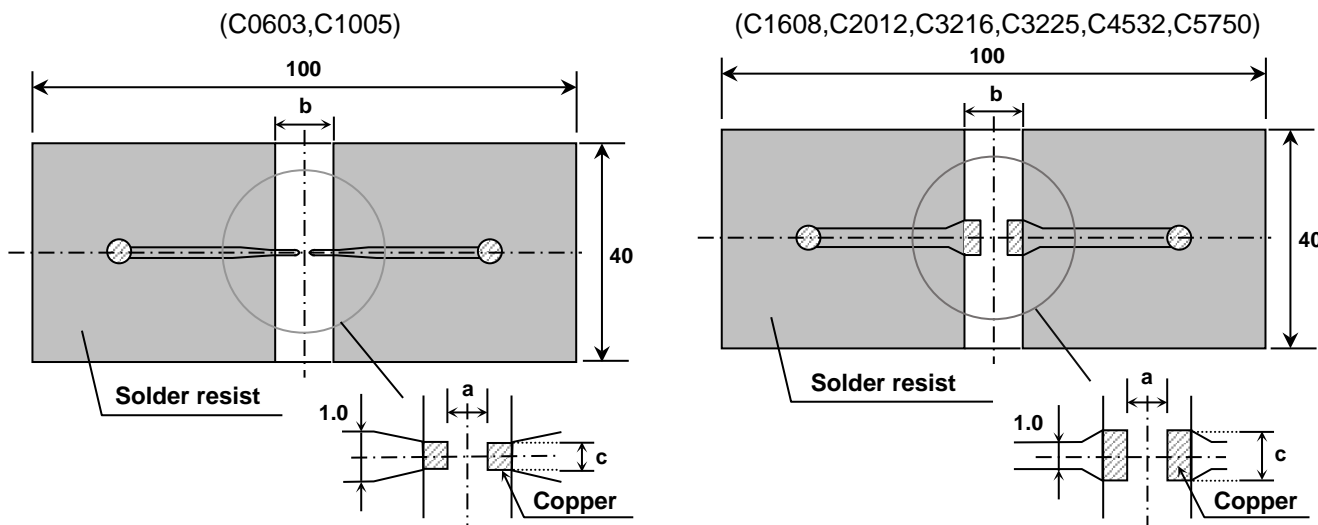

### Appendix2 P.C. Board for reliability test

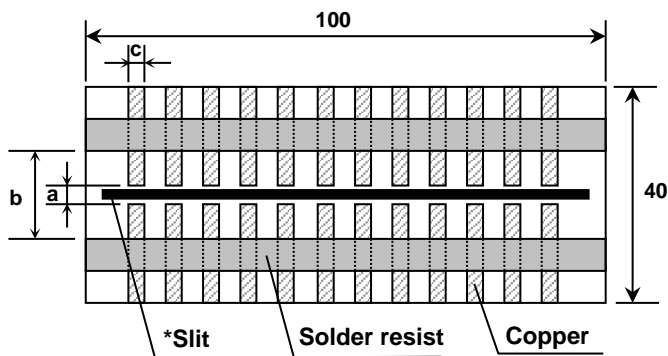

\* It is recommended to provide a slit on P.C.Board for C3225,C4532 and C5750.

(Unit : mm)

Case size / Symbol	a	b	c
C0603 [CC0201]	0.3	0.8	0.3
C1005 [CC0402]	0.4	1.5	0.5
C1608 [CC0603]	1.0	3.0	1.2
C2012 [CC0805]	1.2	4.0	1.65
C3216 [CC1206]	2.2	5.0	2.0
C3225 [CC1210]	2.2	5.0	2.9
C4532 [CC1812]	3.5	7.0	3.7
C5750 [CC2220]	4.5	8.0	5.6

1. Material : Glass Epoxy(As per JIS C6484 GE4)

2. Thickness : Appendix 1 — 0.8mm (C0603,C1005)  
 — 1.6mm (C1608,C2012,C3216,C3225,C4532,C5750)  
 : Appendix 2 — 1.6mm

Copper(Thickness:0.035mm)  
 Solder resist

## 8. INSIDE STRUCTURE AND MATERIAL

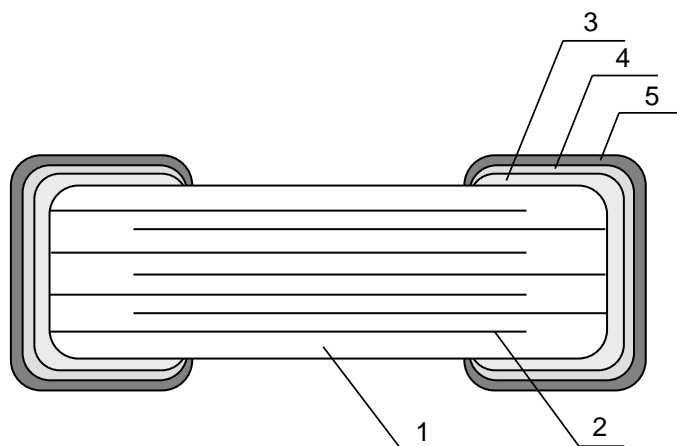

No.	NAME	MATERIAL	
		Class1	Class2
1	Dielectric	CaZrO <sub>3</sub>	BaTiO <sub>3</sub>
2	Electrode	Nickel (Ni)	
3	Termination	Copper (Cu)	
4		Nickel (Ni)	
5		Tin (Sn)	

## 9. PACKAGING

Packaging shall be done to protect the components from the damage during transportation and storing, and a label which has the following information shall be attached.

9.1 Each plastic bag for bulk packaging contains 1000pcs. And the minimum quantity for Bulk packaging is 1000pcs.

9.2 Tape packaging is as per 13. TAPE PACKAGING SPECIFICATION.

\* C0603[CC0201],C1005[CC0402] type is applicable to tape packaging only.

- 1) Inspection No.\*
- 2) TDK P/N
- 3) Customer's P/N
- 4) Quantity

\*Composition of Inspection No.

Example     F 1 A - 23 - 001  
                   (a) (b) (c)     (d)     (e)

- (a) Line code
- (b) Last digit of the year
- (c) Month and A for January and B for February and so on. (Skip I)
- (d) Inspection Date of the month.
- (e) Serial No. of the day

\*Composition of new Inspection No.

(Implemented on and after May 1, 2019 in sequence)

Example     

I	F	1	E	2	3	A	0	0	1
---	---	---	---	---	---	---	---	---	---

  
                   (a) (b) (c) (d)     (e)     (f)     (g)

- (a) Prefix
- (b) Line code
- (c) Last digit of the year
- (d) Month and A for January and B for February and so on. (Skip I)
- (e) Inspection Date of the month.
- (f) Serial No. of the day(00 ~ ZZ)
- (g) Suffix(00 ~ ZZ)

\* It was shifted to the new inspection No. on and after May 2019, but the implementation timing may be different depending on shipment bases. Until the shift is completed, either current or new composition of inspection No. will be applied.

## 10. RECOMMENDATION

As for C3225[CC1210] and larger, It is recommended to provide a slit (about 1mm width) in the board under the components to improve washing Flux. And please make sure to dry detergent up completely before.

## 11. SOLDERING CONDITION

As for C0603 [CC0201], C1005[CC0402], C3225[CC1210] and larger, reflow soldering only. For other case sizes than the above, reflow soldering is recommended.

## 12. CAUTION

No.	Process	Condition
1	Operating Condition (Storage, Use, Transportation)	<p>1-1. Storage, Use            The capacitors must be stored in an ambient temperature of 5 to 40°C with a relative humidity of 20 to 70%RH. JIS C 60721-3-1 Class 1K2 should be followed for the other climatic conditions.</p> <ol style="list-style-type: none"> <li>1) High temperature and humidity environment may affect a capacitor's solder ability because it accelerates terminal oxidization. They also deteriorate performance of taping and packaging. Therefore, SMD capacitors shall be used within 6 months. For capacitors with terminal electrodes consisting of silver or silver-palladium which tend to become oxidized or sulfurized, use as soon as possible, such as within one month after opening the bag.</li> <li>2) When capacitors are stored for a longer time period than 6 months, confirm the solderability of the capacitors prior to use. During storage, keep the minimum packaging unit in its original packaging without opening it. Do not deviate from the above temperature and humidity conditions even for a short term.</li> <li>3) Corrosive gasses in the air or atmosphere may result in deterioration of the reliability, such as poor solderability of the terminal electrodes. Do not store capacitors where they will be exposed to corrosive gas (e.g., hydrogen sulfide, sulfur dioxide, chlorine ammonia etc.)</li> <li>4) Solderability and electrical performance may deteriorate due to photochemical change in the terminal electrode if stored in direct sunlight, or due to condensation from rapid changes in humidity. The capacitors especially which use resin material must be operated and stored in an environment free of dew condensation, as moisture absorption due to condensation may affect the performance.</li> <li>5) Refer to JIS C 60721-3-1, class 1K2 for other climate conditions.</li> </ol> <p>1-2. Handling in transportation            In case of the transportation of the capacitors, the performance of the capacitors may be deteriorated depending on the transportation condition.            (Refer to JEITA RCR-2335C 9.2 Handling in transportation)</p>
2	Circuit design  Caution	<p>2-1. Operating temperature</p> <ol style="list-style-type: none"> <li>1) Upper category temperature (maximum operating temperature) is specified. It is necessary to select a capacitor whose rated temperature is higher than the operating temperature. Also, it is necessary to consider the temperature distribution in the equipment and seasonal temperature variation.</li> <li>2) Surface temperature including self heating should be below maximum operating temperature. Due to dielectric loss, capacitors will heat itself when AC is applied due to ESR. Especially at high frequencies, please be careful that the heat might be so extreme. Also, even if the surface temperature of the capacitor includes self-heating and is the maximum operating temperature or lower, excessive heating of the capacitor due to self-heating may cause deterioration of the characteristics and reliability of the capacitor. The self-heating temperature rise of the capacitor changes depending on the difference in heat radiation due to the mounting method to the device, the ambient temperature, the cooling method of the device and circuit board material and the design, etc. The load should be contained so that the self-heating temperature rise of the capacitor body in a natural convection environment at an ambient temperature of 25°C remain below 20°C. When using in a high-frequency circuit or a circuit in which a capacitor generates heat, such as when a high-frequency ripple current flows, pay attention to the above precautions. (Note that accurate measurement may not be possible with self-heating measurement when the equipment applies cooling other than natural convection such as a cooling fan.)</li> <li>3) The electrical characteristics of the capacitors will vary depending on the temperature. The capacitors should be selected and designed in taking the temperature into consideration.</li> </ol>

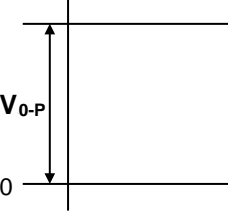
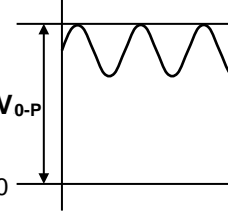
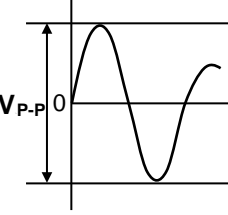
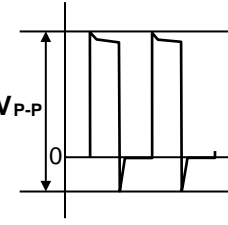
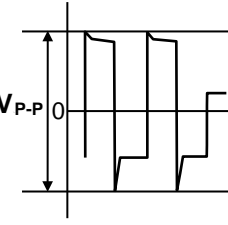
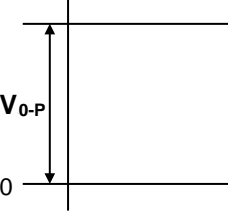
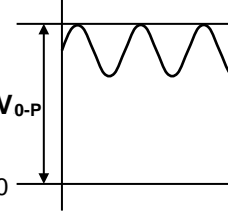
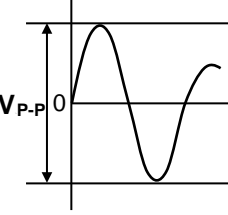
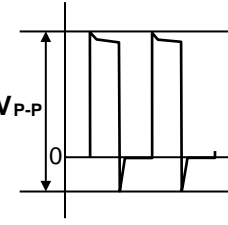
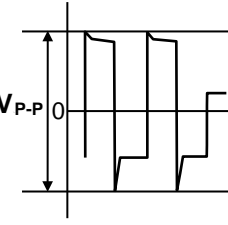
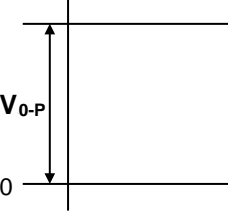
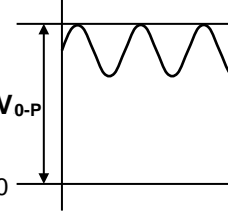
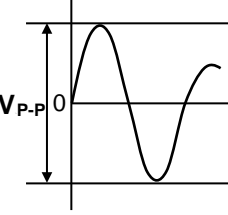
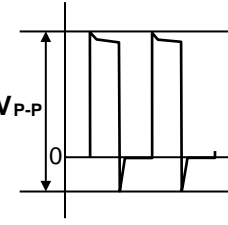
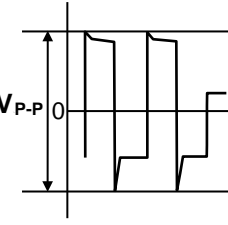

No.	Process	Condition																
2	Circuit design  Caution	<p>2-2. When overvoltage is applied                      Applying overvoltage to a capacitor may cause dielectric breakdown and result in a short circuit. The duration until dielectric breakdown depends on the applied voltage and the ambient temperature.</p> <p>2-3. Operating voltage</p> <p>1) Operating voltage across the terminals should be below the rated voltage.                      When AC and DC are super imposed, <math>V_{0-P}</math> must be below the rated voltage.                      — (1) and (2)                      AC or pulse with overshooting, <math>V_{P-P}</math> must be below the rated voltage.                      — (3), (4) and (5)                      When the voltage is started to apply to the circuit or it is stopped applying, the irregular voltage may be generated for a transit period because of resonance or switching. Be sure to use the capacitors within rated voltage containing these Irregular voltage.</p> <table border="1" data-bbox="462 649 1444 1243"> <thead> <tr> <th data-bbox="462 649 662 694">Voltage</th> <th data-bbox="662 649 922 694">(1) DC voltage</th> <th data-bbox="922 649 1182 694">(2) DC+AC voltage</th> <th data-bbox="1182 649 1444 694">(3) AC voltage</th> </tr> </thead> <tbody> <tr> <td data-bbox="462 694 662 929">Positional Measurement (Rated voltage)</td> <td data-bbox="662 694 922 929">  </td> <td data-bbox="922 694 1182 929">  </td> <td data-bbox="1182 694 1444 929">  </td> </tr> <tr> <th data-bbox="462 952 662 996">Voltage</th> <th data-bbox="662 952 922 996">(4) Pulse voltage (A)</th> <th data-bbox="922 952 1182 996">(5) Pulse voltage (B)</th> <th></th> </tr> <tr> <td data-bbox="462 996 662 1243">Positional Measurement (Rated voltage)</td> <td data-bbox="662 996 922 1243">  </td> <td data-bbox="922 996 1182 1243">  </td> <td></td> </tr> </tbody> </table> <p>2) Even below the rated voltage, if repetitive high frequency AC or pulse is applied, the reliability of the capacitors may be reduced.</p> <p>3) The effective capacitance will vary depending on applied DC and AC voltages. The capacitors should be selected and designed in taking the voltages into consideration.</p> <p>4) Abnormal voltage (surge voltage, static electricity, pulse voltage, etc.) shall not exceed the rated voltage.</p> <p>5) When capacitors are used in a series connection, it is necessary to add a balancing circuit such as voltage dividing resistors in order to avoid an imbalance in the voltage applied to each capacitor.</p> <p>2-4. Frequency                      When the capacitors (Class 2) are used in AC and/or pulse voltages, the capacitors may vibrate themselves and generate audible sound.</p>	Voltage	(1) DC voltage	(2) DC+AC voltage	(3) AC voltage	Positional Measurement (Rated voltage)				Voltage	(4) Pulse voltage (A)	(5) Pulse voltage (B)		Positional Measurement (Rated voltage)			
Voltage	(1) DC voltage	(2) DC+AC voltage	(3) AC voltage															
Positional Measurement (Rated voltage)																		
Voltage	(4) Pulse voltage (A)	(5) Pulse voltage (B)																
Positional Measurement (Rated voltage)																		

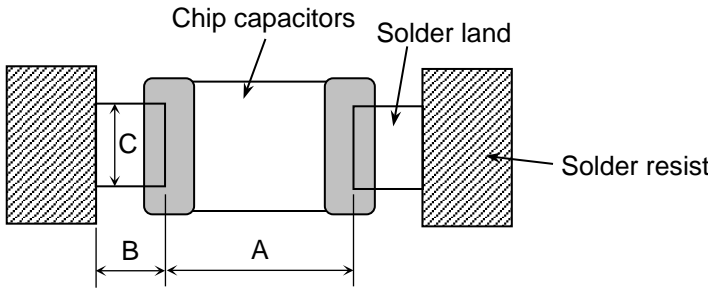
No.	Process	Condition																																																																																																
3	Designing P.C.board	<p>The amount of solder at the terminations has a direct effect on the reliability of the capacitors.</p> <ol style="list-style-type: none"> <li>1) The greater the amount of solder, the higher the stress on the chip capacitors, and the more likely that it will break. When designing a P.C.board, determine the shape and size of the solder lands to have proper amount of solder on the terminations.</li> <li>2) Avoid using common solder land for multiple terminations and provide individual solder land for each terminations.</li> <li>3) Size and recommended land dimensions.</li> </ol> <div style="text-align: center;">  </div> <table border="1" style="width: 100%; border-collapse: collapse; margin-top: 10px;"> <thead> <tr> <th colspan="2" style="text-align: left;">Reflow soldering</th> <th colspan="4" style="text-align: right;">(Unit : mm)</th> </tr> <tr> <th style="text-align: left;">Case size</th> <th style="text-align: left;">C0603 [CC0201]</th> <th style="text-align: left;">C1005 [CC0402]</th> <th style="text-align: left;">C1608 [CC0603]</th> <th style="text-align: left;">C2012 [CC0805]</th> <th></th> </tr> </thead> <tbody> <tr> <td style="text-align: left;">Symbol</td> <td></td> <td></td> <td></td> <td></td> <td></td> </tr> <tr> <td style="text-align: left;">A</td> <td>0.25 ~ 0.35</td> <td>0.3 ~ 0.5</td> <td>0.6 ~ 0.8</td> <td>0.9 ~ 1.2</td> <td></td> </tr> <tr> <td style="text-align: left;">B</td> <td>0.2 ~ 0.3</td> <td>0.35 ~ 0.45</td> <td>0.6 ~ 0.8</td> <td>0.7 ~ 0.9</td> <td></td> </tr> <tr> <td style="text-align: left;">C</td> <td>0.25 ~ 0.35</td> <td>0.4 ~ 0.6</td> <td>0.6 ~ 0.8</td> <td>0.9 ~ 1.2</td> <td></td> </tr> </tbody> </table> <table border="1" style="width: 100%; border-collapse: collapse; margin-top: 10px;"> <thead> <tr> <th style="text-align: left;">Case size</th> <th style="text-align: left;">C3216 [CC1206]</th> <th style="text-align: left;">C3225 [CC1210]</th> <th style="text-align: left;">C4532 [CC1812]</th> <th style="text-align: left;">C5750 [CC2220]</th> <th></th> </tr> </thead> <tbody> <tr> <td style="text-align: left;">Symbol</td> <td></td> <td></td> <td></td> <td></td> <td></td> </tr> <tr> <td style="text-align: left;">A</td> <td>2.0 ~ 2.4</td> <td>2.0 ~ 2.4</td> <td>3.1 ~ 3.7</td> <td>4.1 ~ 4.8</td> <td></td> </tr> <tr> <td style="text-align: left;">B</td> <td>1.0 ~ 1.2</td> <td>1.0 ~ 1.2</td> <td>1.2 ~ 1.4</td> <td>1.2 ~ 1.4</td> <td></td> </tr> <tr> <td style="text-align: left;">C</td> <td>1.1 ~ 1.6</td> <td>1.9 ~ 2.5</td> <td>2.4 ~ 3.2</td> <td>4.0 ~ 5.0</td> <td></td> </tr> </tbody> </table> <table border="1" style="width: 100%; border-collapse: collapse; margin-top: 10px;"> <thead> <tr> <th colspan="2" style="text-align: left;">Flow soldering (Unrecommend)</th> <th colspan="3" style="text-align: right;">(Unit : mm)</th> </tr> <tr> <th style="text-align: left;">Case size</th> <th style="text-align: left;">C1608 [CC0603]</th> <th style="text-align: left;">C2012 [CC0805]</th> <th style="text-align: left;">C3216 [CC1206]</th> <th></th> </tr> </thead> <tbody> <tr> <td style="text-align: left;">Symbol</td> <td></td> <td></td> <td></td> <td></td> </tr> <tr> <td style="text-align: left;">A</td> <td>0.7 ~ 1.0</td> <td>1.0 ~ 1.3</td> <td>2.1 ~ 2.5</td> <td></td> </tr> <tr> <td style="text-align: left;">B</td> <td>0.8 ~ 1.0</td> <td>1.0 ~ 1.2</td> <td>1.1 ~ 1.3</td> <td></td> </tr> <tr> <td style="text-align: left;">C</td> <td>0.6 ~ 0.8</td> <td>0.8 ~ 1.1</td> <td>1.0 ~ 1.3</td> <td></td> </tr> </tbody> </table>	Reflow soldering		(Unit : mm)				Case size	C0603 [CC0201]	C1005 [CC0402]	C1608 [CC0603]	C2012 [CC0805]		Symbol						A	0.25 ~ 0.35	0.3 ~ 0.5	0.6 ~ 0.8	0.9 ~ 1.2		B	0.2 ~ 0.3	0.35 ~ 0.45	0.6 ~ 0.8	0.7 ~ 0.9		C	0.25 ~ 0.35	0.4 ~ 0.6	0.6 ~ 0.8	0.9 ~ 1.2		Case size	C3216 [CC1206]	C3225 [CC1210]	C4532 [CC1812]	C5750 [CC2220]		Symbol						A	2.0 ~ 2.4	2.0 ~ 2.4	3.1 ~ 3.7	4.1 ~ 4.8		B	1.0 ~ 1.2	1.0 ~ 1.2	1.2 ~ 1.4	1.2 ~ 1.4		C	1.1 ~ 1.6	1.9 ~ 2.5	2.4 ~ 3.2	4.0 ~ 5.0		Flow soldering (Unrecommend)		(Unit : mm)			Case size	C1608 [CC0603]	C2012 [CC0805]	C3216 [CC1206]		Symbol					A	0.7 ~ 1.0	1.0 ~ 1.3	2.1 ~ 2.5		B	0.8 ~ 1.0	1.0 ~ 1.2	1.1 ~ 1.3		C	0.6 ~ 0.8	0.8 ~ 1.1	1.0 ~ 1.3	
Reflow soldering		(Unit : mm)																																																																																																
Case size	C0603 [CC0201]	C1005 [CC0402]	C1608 [CC0603]	C2012 [CC0805]																																																																																														
Symbol																																																																																																		
A	0.25 ~ 0.35	0.3 ~ 0.5	0.6 ~ 0.8	0.9 ~ 1.2																																																																																														
B	0.2 ~ 0.3	0.35 ~ 0.45	0.6 ~ 0.8	0.7 ~ 0.9																																																																																														
C	0.25 ~ 0.35	0.4 ~ 0.6	0.6 ~ 0.8	0.9 ~ 1.2																																																																																														
Case size	C3216 [CC1206]	C3225 [CC1210]	C4532 [CC1812]	C5750 [CC2220]																																																																																														
Symbol																																																																																																		
A	2.0 ~ 2.4	2.0 ~ 2.4	3.1 ~ 3.7	4.1 ~ 4.8																																																																																														
B	1.0 ~ 1.2	1.0 ~ 1.2	1.2 ~ 1.4	1.2 ~ 1.4																																																																																														
C	1.1 ~ 1.6	1.9 ~ 2.5	2.4 ~ 3.2	4.0 ~ 5.0																																																																																														
Flow soldering (Unrecommend)		(Unit : mm)																																																																																																
Case size	C1608 [CC0603]	C2012 [CC0805]	C3216 [CC1206]																																																																																															
Symbol																																																																																																		
A	0.7 ~ 1.0	1.0 ~ 1.3	2.1 ~ 2.5																																																																																															
B	0.8 ~ 1.0	1.0 ~ 1.2	1.1 ~ 1.3																																																																																															
C	0.6 ~ 0.8	0.8 ~ 1.1	1.0 ~ 1.3																																																																																															

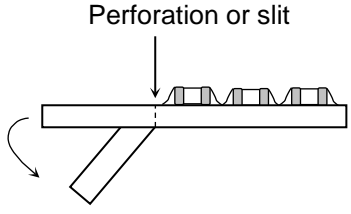
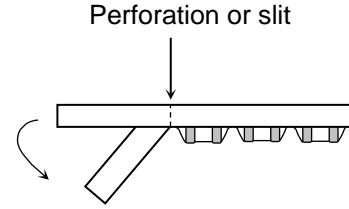
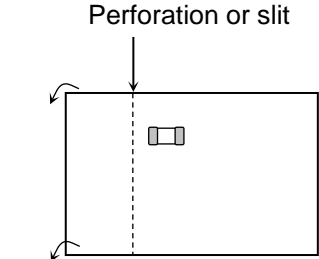
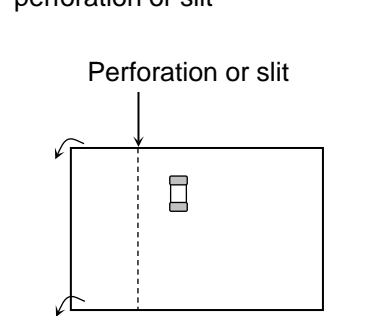
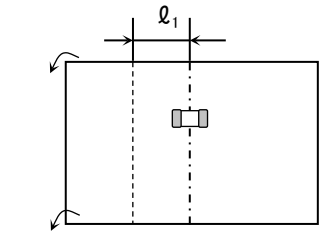
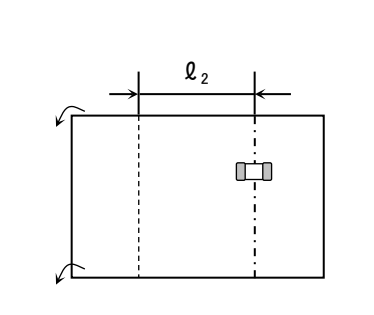
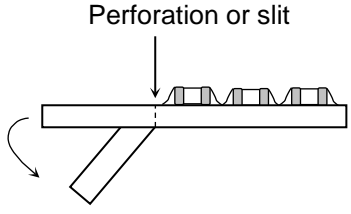
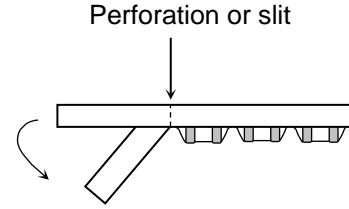
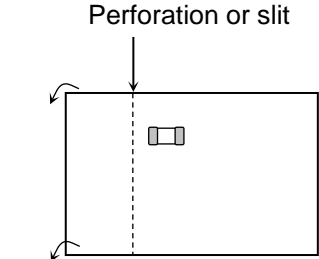
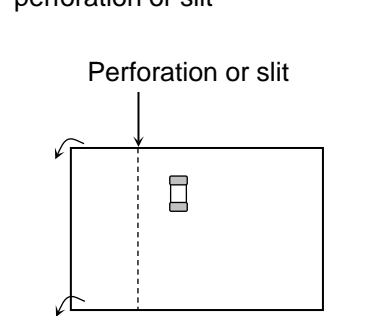
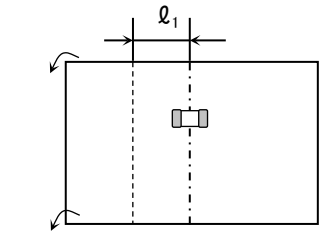
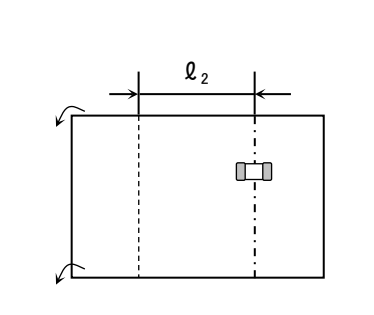
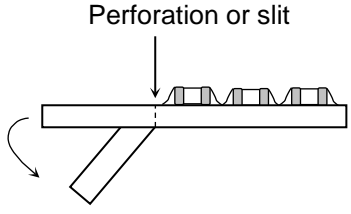
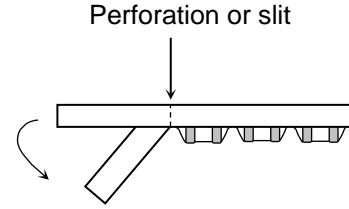
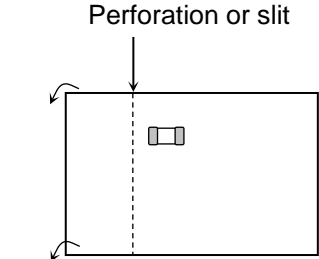
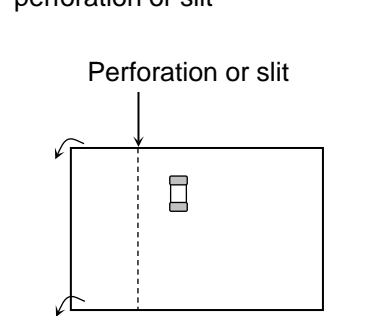
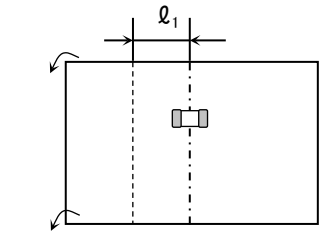
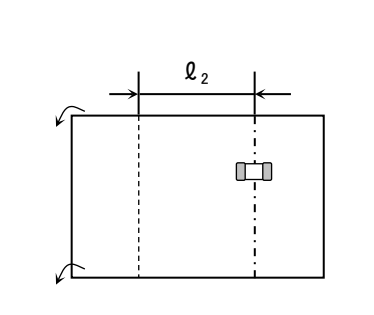
No.	Process	Condition												
3	Designing P.C.board	<p data-bbox="427 219 1098 253">4) Recommended chip capacitors layout is as following.</p> <table border="1" data-bbox="464 286 1422 1709"> <thead> <tr> <th data-bbox="464 286 651 365"></th> <th data-bbox="651 286 1034 365">Disadvantage against bending stress</th> <th data-bbox="1034 286 1422 365">Advantage against bending stress</th> </tr> </thead> <tbody> <tr> <td data-bbox="464 365 651 779">Mounting face</td> <td data-bbox="651 365 1034 779"> <p data-bbox="738 432 946 465">Perforation or slit</p>  <p data-bbox="691 689 946 757">Break P.C.board with mounted side up.</p> </td> <td data-bbox="1034 365 1422 779"> <p data-bbox="1121 432 1329 465">Perforation or slit</p>  <p data-bbox="1074 689 1329 757">Break P.C.board with mounted side down.</p> </td> </tr> <tr> <td data-bbox="464 779 651 1227">Chip arrangement (Direction)</td> <td data-bbox="651 779 1034 1227"> <p data-bbox="738 902 946 936">Perforation or slit</p>  </td> <td data-bbox="1034 779 1422 1227"> <p data-bbox="1121 902 1329 936">Perforation or slit</p>  </td> </tr> <tr> <td data-bbox="464 1227 651 1709">Distance from slit</td> <td data-bbox="651 1227 1034 1709"> <p data-bbox="659 1238 994 1272">Closer to slit is higher stress</p>  <p data-bbox="882 1608 994 1641"><math>(l_1 &lt; l_2)</math></p> </td> <td data-bbox="1034 1227 1422 1709"> <p data-bbox="1042 1238 1377 1272">Away from slit is less stress</p>  <p data-bbox="1265 1608 1377 1641"><math>(l_1 &lt; l_2)</math></p> </td> </tr> </tbody> </table>		Disadvantage against bending stress	Advantage against bending stress	Mounting face	<p data-bbox="738 432 946 465">Perforation or slit</p>  <p data-bbox="691 689 946 757">Break P.C.board with mounted side up.</p>	<p data-bbox="1121 432 1329 465">Perforation or slit</p>  <p data-bbox="1074 689 1329 757">Break P.C.board with mounted side down.</p>	Chip arrangement (Direction)	<p data-bbox="738 902 946 936">Perforation or slit</p> 	<p data-bbox="1121 902 1329 936">Perforation or slit</p> 	Distance from slit	<p data-bbox="659 1238 994 1272">Closer to slit is higher stress</p>  <p data-bbox="882 1608 994 1641"><math>(l_1 &lt; l_2)</math></p>	<p data-bbox="1042 1238 1377 1272">Away from slit is less stress</p>  <p data-bbox="1265 1608 1377 1641"><math>(l_1 &lt; l_2)</math></p>
	Disadvantage against bending stress	Advantage against bending stress												
Mounting face	<p data-bbox="738 432 946 465">Perforation or slit</p>  <p data-bbox="691 689 946 757">Break P.C.board with mounted side up.</p>	<p data-bbox="1121 432 1329 465">Perforation or slit</p>  <p data-bbox="1074 689 1329 757">Break P.C.board with mounted side down.</p>												
Chip arrangement (Direction)	<p data-bbox="738 902 946 936">Perforation or slit</p> 	<p data-bbox="1121 902 1329 936">Perforation or slit</p> 												
Distance from slit	<p data-bbox="659 1238 994 1272">Closer to slit is higher stress</p>  <p data-bbox="882 1608 994 1641"><math>(l_1 &lt; l_2)</math></p>	<p data-bbox="1042 1238 1377 1272">Away from slit is less stress</p>  <p data-bbox="1265 1608 1377 1641"><math>(l_1 &lt; l_2)</math></p>												

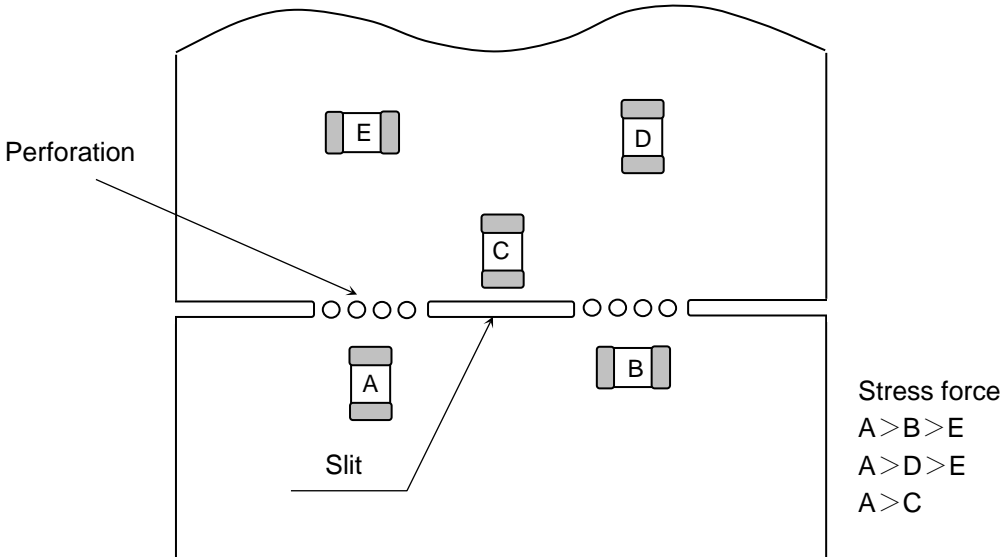
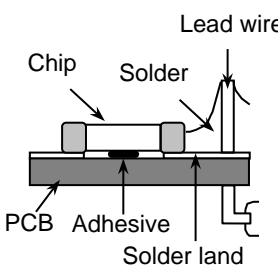
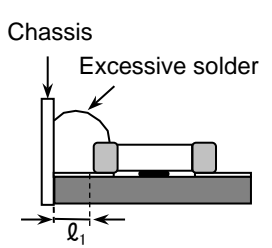
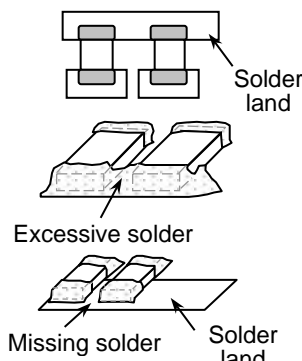
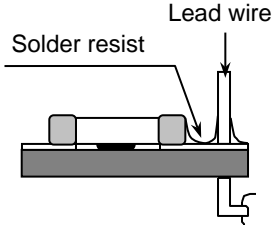
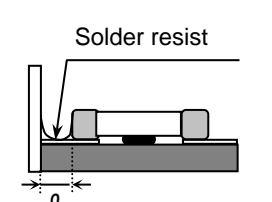
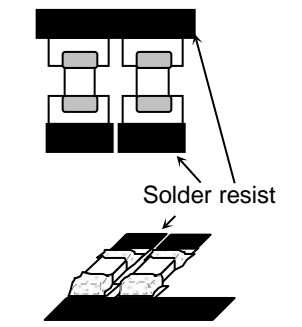
No.	Process	Condition	
3	Designing P.C.board	<p>5) Mechanical stress varies according to location of chip capacitors on the P.C.board.</p>  <p>When dividing printed wiring boards, the intensities of mechanical stress applied to capacitors are different according to each dividing method in the order of : Push-back &lt; Slit &lt; V-groove &lt; Perforation. Therefore consider not only position of capacitors, but also the way of the dividing the printed wiring boards.</p>	
6) Layout recommendation			
Example	Use of common solder land	Soldering with chassis	Use of common solder land with other SMD
Need to avoid			
Recommendation		 <p><math>l_2 &gt; l_1</math></p>	

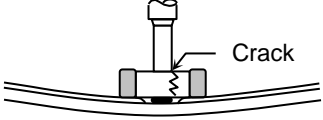
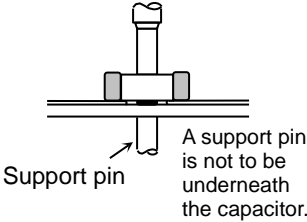
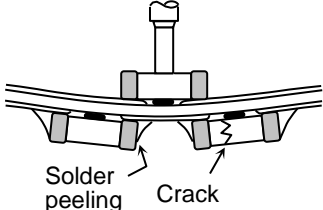
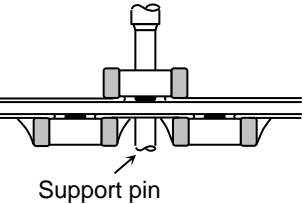
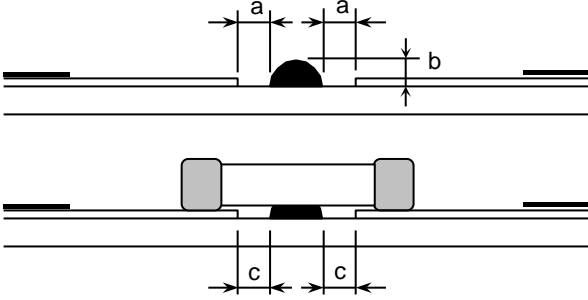
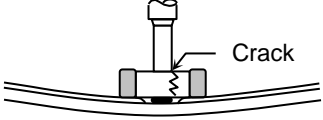
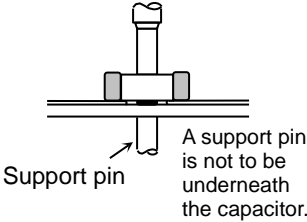
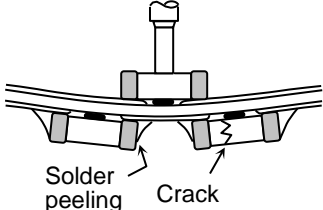
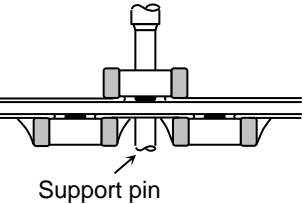
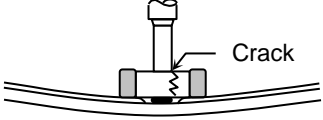
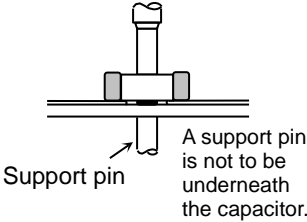
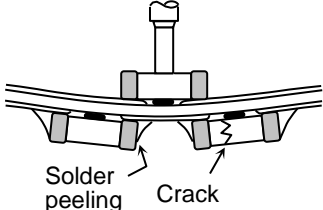
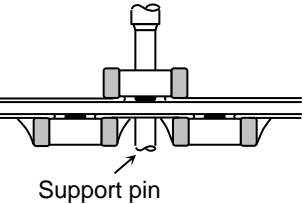
No.	Process	Condition															
4	Mounting	<p>4-1. Stress from mounting head                      If the mounting head is adjusted too low, it may induce excessive stress in the chip capacitors to result in cracking. Please take following precautions.</p> <ol style="list-style-type: none"> <li>1) Adjust the bottom dead center of the mounting head to reach on the P.C.board surface and not press it.</li> <li>2) Adjust the mounting head pressure to be 1 to 3N of static weight.</li> <li>3) To minimize the impact energy from mounting head, it is important to provide support from the bottom side of the P.C.board.                      See following examples.</li> </ol> <table border="1" data-bbox="475 629 1423 1211"> <thead> <tr> <th></th> <th>Not recommended</th> <th>Recommended</th> </tr> </thead> <tbody> <tr> <td>Single-sided mounting</td> <td></td> <td></td> </tr> <tr> <td>Double-sides mounting</td> <td></td> <td></td> </tr> </tbody> </table> <p>When the centering jaw is worn out, it may give mechanical impact on the capacitors to cause crack. Please control the close up dimension of the centering jaw and provide sufficient preventive maintenance and replacement of it.</p> <p>4-2. Amount of adhesive</p>  <p>Example : C2012 [CC0805], C3216 [CC1206]</p> <table border="1" data-bbox="655 1832 1209 2002"> <tbody> <tr> <td>a</td> <td>0.2mm min.</td> </tr> <tr> <td>b</td> <td>70 ~ 100µm</td> </tr> <tr> <td>c</td> <td>Do not touch the solder land</td> </tr> </tbody> </table>		Not recommended	Recommended	Single-sided mounting			Double-sides mounting			a	0.2mm min.	b	70 ~ 100µm	c	Do not touch the solder land
	Not recommended	Recommended															
Single-sided mounting																	
Double-sides mounting																	
a	0.2mm min.																
b	70 ~ 100µm																
c	Do not touch the solder land																

No.	Process	Condition														
5	Soldering	<p>5-1. Flux selection Flux can seriously affect the performance of capacitors. Confirm the following to select the appropriate flux.</p> <ol style="list-style-type: none"> <li>1) It is recommended to use a mildly activated rosin flux (less than 0.1wt% chlorine). Strong flux is not recommended.</li> <li>2) Excessive flux must be avoided. Please provide proper amount of flux.</li> <li>3) When water-soluble flux is used, enough washing is necessary.</li> </ol> <p>5-2. Recommended soldering profile : Reflow method Refer to the following temperature profile at Reflow soldering.</p> <div style="text-align: center;"> <p>Reflow soldering</p> </div> <p>Reflow soldering is recommended for C1608,C2012,C3216 types, but only reflow soldering is allowed for other case sizes.</p> <p>5-3. Recommended soldering peak temp and peak temp duration for Reflow soldering Pb free solder is recommended, but if Sn-37Pb must be used, refer to below.</p> <table border="1" style="margin-left: auto; margin-right: auto;"> <thead> <tr> <th rowspan="2" style="text-align: center;">Temp./Duration</th> <th colspan="2" style="text-align: center;">Reflow soldering</th> </tr> <tr> <th style="text-align: center;">Peak temp(°C)</th> <th style="text-align: center;">Duration(sec.)</th> </tr> </thead> <tbody> <tr> <td style="text-align: center;">Solder</td> <td></td> <td></td> </tr> <tr> <td style="text-align: center;">Lead Free Solder</td> <td style="text-align: center;">260 max.</td> <td style="text-align: center;">10 max.</td> </tr> <tr> <td style="text-align: center;">Sn-Pb Solder</td> <td style="text-align: center;">230 max.</td> <td style="text-align: center;">20 max.</td> </tr> </tbody> </table> <p>Recommended solder compositions Lead Free Solder : Sn-3.0Ag-0.5Cu</p>	Temp./Duration	Reflow soldering		Peak temp(°C)	Duration(sec.)	Solder			Lead Free Solder	260 max.	10 max.	Sn-Pb Solder	230 max.	20 max.
Temp./Duration	Reflow soldering															
	Peak temp(°C)	Duration(sec.)														
Solder																
Lead Free Solder	260 max.	10 max.														
Sn-Pb Solder	230 max.	20 max.														

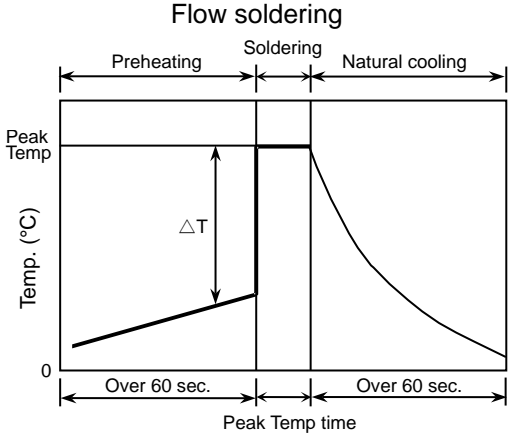
No.	Process	Condition																									
5	Soldering	<p>5-4. Soldering profile : Flow method (Unrecommend) Refer to the following temperature profile at Flow soldering.</p> <div style="text-align: center;">  <p>The graph shows a temperature profile for flow soldering. It is divided into three phases: Preheating, Soldering, and Natural cooling. The y-axis is labeled 'Temp. (°C)' and the x-axis is labeled 'Time'. The Preheating phase shows a linear increase in temperature from 0 to a peak temperature, with a duration of 'Over 60 sec.' and a temperature difference <math>\Delta T</math> indicated. The Soldering phase is a constant temperature plateau, also with a duration of 'Over 60 sec.' and labeled 'Peak Temp time'. The Natural cooling phase shows a non-linear decrease in temperature, also with a duration of 'Over 60 sec.'.</p> </div> <p>Reflow soldering is recommended for C1608,C2012,C3216 types.</p> <p>5-5. Recommended soldering peak temp and peak temp duration for Flow soldering Pb free solder is recommended, but if Sn-37Pb must be used, refer to below.</p> <table border="1" data-bbox="588 925 1332 1160"> <thead> <tr> <th rowspan="2">Temp./Duration</th> <th colspan="2">Flow soldering</th> </tr> <tr> <th>Peak temp(°C)</th> <th>Duration(sec.)</th> </tr> </thead> <tbody> <tr> <td>Solder</td> <td></td> <td></td> </tr> <tr> <td>Lead Free Solder</td> <td>260 max.</td> <td>5 max.</td> </tr> <tr> <td>Sn-Pb Solder</td> <td>250 max.</td> <td>3 max.</td> </tr> </tbody> </table> <p>Recommended solder compositions Lead Free Solder : Sn-3.0Ag-0.5Cu</p> <p>5-6. Avoiding thermal shock</p> <p>1) Preheating condition</p> <table border="1" data-bbox="539 1352 1414 1619"> <thead> <tr> <th>Soldering</th> <th>Case size</th> <th>Temp. (°C)</th> </tr> </thead> <tbody> <tr> <td rowspan="2">Reflow soldering</td> <td>C0603(CC0201),C1005(CC0402), C1608(CC0603),C2012(CC0805), C3216(CC1206)</td> <td><math>\Delta T \leq 150</math></td> </tr> <tr> <td>C3225(CC1210), C4532(CC1812), C5750(CC2220)</td> <td><math>\Delta T \leq 130</math></td> </tr> <tr> <td>Flow soldering</td> <td>C1608(CC0603),C2012(CC0805), C3216(CC1206)</td> <td><math>\Delta T \leq 150</math></td> </tr> </tbody> </table> <p>2) Cooling condition Natural cooling using air is recommended. If the chips are dipped into a solvent for cleaning, the temperature difference (<math>\Delta T</math>) must be less than 100°C.</p>	Temp./Duration	Flow soldering		Peak temp(°C)	Duration(sec.)	Solder			Lead Free Solder	260 max.	5 max.	Sn-Pb Solder	250 max.	3 max.	Soldering	Case size	Temp. (°C)	Reflow soldering	C0603(CC0201),C1005(CC0402), C1608(CC0603),C2012(CC0805), C3216(CC1206)	$\Delta T \leq 150$	C3225(CC1210), C4532(CC1812), C5750(CC2220)	$\Delta T \leq 130$	Flow soldering	C1608(CC0603),C2012(CC0805), C3216(CC1206)	$\Delta T \leq 150$
Temp./Duration	Flow soldering																										
	Peak temp(°C)	Duration(sec.)																									
Solder																											
Lead Free Solder	260 max.	5 max.																									
Sn-Pb Solder	250 max.	3 max.																									
Soldering	Case size	Temp. (°C)																									
Reflow soldering	C0603(CC0201),C1005(CC0402), C1608(CC0603),C2012(CC0805), C3216(CC1206)	$\Delta T \leq 150$																									
	C3225(CC1210), C4532(CC1812), C5750(CC2220)	$\Delta T \leq 130$																									
Flow soldering	C1608(CC0603),C2012(CC0805), C3216(CC1206)	$\Delta T \leq 150$																									

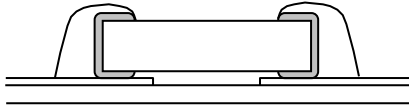
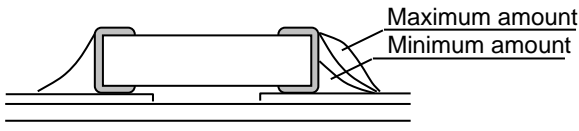
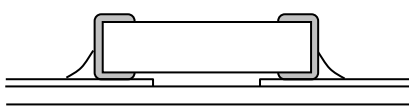
No.	Process	Condition
5	Soldering	<p data-bbox="437 215 699 241">5-7. Amount of solder</p> <p data-bbox="520 248 1461 338">Excessive solder will induce higher tensile force in chip capacitors when temperature changes and it may result in chip cracking. In sufficient solder may detach the capacitors from the P.C.board.</p> <hr/> <div style="display: flex; justify-content: space-between;"> <div data-bbox="496 398 619 461">Excessive solder</div> <div data-bbox="662 398 1070 501">  </div> <div data-bbox="1121 383 1414 472">Higher tensile force in chip capacitors to cause crack</div> </div> <hr/> <div style="display: flex; justify-content: space-between;"> <div data-bbox="496 566 612 593">Adequate</div> <div data-bbox="662 521 1241 647">  </div> </div> <hr/> <div style="display: flex; justify-content: space-between;"> <div data-bbox="496 703 628 766">Insufficient solder</div> <div data-bbox="662 703 1070 806">  </div> <div data-bbox="1121 674 1414 792">Low robustness may cause contact failure or chip capacitors come off the P.C.board.</div> </div> <hr/> <p data-bbox="437 864 647 891">5-8. Sn-Zn solder</p> <p data-bbox="464 898 1155 956">Sn-Zn solder affects product reliability. Please contact TDK in advance when utilize Sn-Zn solder.</p> <p data-bbox="437 994 863 1021">5-9. Countermeasure for tombstone</p> <p data-bbox="464 1028 1449 1211">The misalignment between the mounted positions of the capacitors and the land patterns should be minimized. The tombstone phenomenon may occur especially the capacitors are mounted (in longitudinal direction) in the same direction of the reflow soldering. (Refer to JEITA RCR-2335C Annex A (Informative), Recommendations to prevent the tombstone phenomenon.)</p>

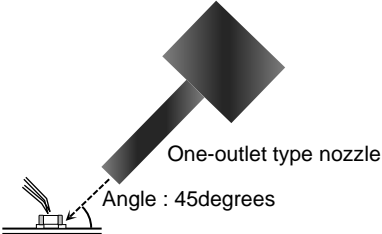

No.	Process	Condition												
6	Solder repairing	<p>Solder repairing is unavoidable, refer to below.</p> <p>6-1.Soldering rework using spot heater Heat stress during rework may possibly be reduced by using a spot heater (also called a “blower”) rather than a soldering iron. It is applied only to adding solder in the case of insufficient solder amount.</p> <p>1) Reworking using a spot heater may suppress the occurrence of cracks in the capacitor compared to using a soldering iron. A spot heater can heat up a capacitor uniformly with a small heat gradient which leads to lower thermal stress caused by quick heating and cooling or localized heating. Moreover, where ultra-small capacitors are mounted close together on a printed circuit board, reworking with a spot heater can eliminate the risk of direct contact between the tip of a soldering iron and a capacitor.</p> <p>2) Rework condition If the blower nozzle of a spot heater is too close to a capacitor, a crack in the capacitor may occur due to heat stress. Below are recommendations for avoiding such an occurrence. Keep more than 5mm between a capacitor and a spot heater nozzle. The blower temperature of the spot heater shall be lower than 400°C. The airflow shall be set as weak as possible. The diameter of the nozzle is recommended to be 2mm(one-outlet type).The size is standard and common. Duration of blowing hot air is recommended to be 10s or less for C1608(CC0603), C2012(CC0805) and C3216(CC1206), and 30s or less for C3225(CC1210), C4532(CC1812) and C5750(CC2220), considering surface area of the capacitor and melting temperature of solder. The angle between the nozzle and the capacitor is recommended to be 45degrees in order to work easily and to avoid partial area heating. As is the case when using a soldering iron, preheating reduces thermal stress on capacitors and improves operating efficiency.</p> <p>• Recommended rework condition (Consult the component manufactures for details.)</p> <table border="1" data-bbox="507 1205 1453 1559"> <tbody> <tr> <td>Distance from nozzle</td> <td>5mm and over</td> </tr> <tr> <td>Nozzle angle</td> <td>45degrees</td> </tr> <tr> <td>Nozzle temp.</td> <td>400°C and less</td> </tr> <tr> <td>Airflow</td> <td>Set as weak as possible (The airflow shall be the minimum value necessary for solder to melt in the conditions mentioned above.)</td> </tr> <tr> <td>Nozzle diameter</td> <td>ø2mm (one-outlet type)</td> </tr> <tr> <td>Blowing duration</td> <td>10s and less (C1608[CC0603], C2012[CC0805], C3216[CC1206]) 30s and less (C3225[CC1210], C4532[CC1812], C5750[CC2220])</td> </tr> </tbody> </table> <p>• Example of recommended spot heater use</p>  <p>3) Amount of solder should be suitable to form a proper fillet shape. Excess solder causes mechanical and thermal stress on a capacitor and results in cracks. Insufficient solder causes weak adherence of the capacitor to the substrate and may result in detachment of a capacitor and deteriorate reliability of the printed wiring board. See the example of appropriate solder fillet shape for 5-5.Amount of solder.</p>	Distance from nozzle	5mm and over	Nozzle angle	45degrees	Nozzle temp.	400°C and less	Airflow	Set as weak as possible (The airflow shall be the minimum value necessary for solder to melt in the conditions mentioned above.)	Nozzle diameter	ø2mm (one-outlet type)	Blowing duration	10s and less (C1608[CC0603], C2012[CC0805], C3216[CC1206]) 30s and less (C3225[CC1210], C4532[CC1812], C5750[CC2220])
Distance from nozzle	5mm and over													
Nozzle angle	45degrees													
Nozzle temp.	400°C and less													
Airflow	Set as weak as possible (The airflow shall be the minimum value necessary for solder to melt in the conditions mentioned above.)													
Nozzle diameter	ø2mm (one-outlet type)													
Blowing duration	10s and less (C1608[CC0603], C2012[CC0805], C3216[CC1206]) 30s and less (C3225[CC1210], C4532[CC1812], C5750[CC2220])													

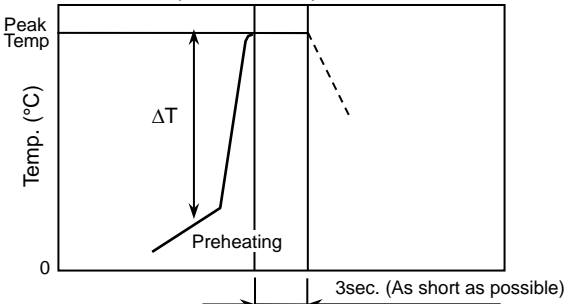
No.	Process	Condition																				
6	Solder repairing	<p>6-2. Solder repair by solder iron</p> <p>1) Selection of the soldering iron tip            Tip temperature of solder iron varies by its type, P.C.board material and solder land size. The higher the tip temperature, the quicker the operation. However, heat shock may cause a crack in the chip capacitors. Please make sure the tip temp. before soldering and keep the peak temp and time in accordance with following recommended condition.</p> <div style="text-align: center;"> <p>Manual soldering (Solder iron)</p>  </div> <p style="text-align: center;">Recommended solder iron condition (Sn-Pb Solder and Lead Free Solder)</p> <table border="1" style="width: 100%; border-collapse: collapse;"> <thead> <tr> <th>Case size</th> <th>Temp. (°C)</th> <th>Duration (sec.)</th> <th>Wattage (W)</th> <th>Shape (mm)</th> </tr> </thead> <tbody> <tr> <td>C0603(CC0201) C1005(CC0402) C1608(CC0603) C2012(CC0805) C3216(CC1206)</td> <td style="text-align: center;">350 max.</td> <td rowspan="2" style="text-align: center;">3 max.</td> <td rowspan="2" style="text-align: center;">20 max.</td> <td rowspan="2" style="text-align: center;">ø3.0 max.</td> </tr> <tr> <td>C3225(CC1210) C4532(CC1812) C5750(CC2220)</td> <td style="text-align: center;">280 max.</td> </tr> </tbody> </table> <p>* Please preheat the chip capacitors with the condition in 6-3 to avoid the thermal shock.</p> <p>2) Direct contact of the soldering iron with ceramic dielectric of chip capacitors may cause crack. Do not touch the ceramic dielectric and the terminations by solder iron.</p> <p>3) It is not recommended to reuse dismantled capacitors.</p> <p>6-3. Avoiding thermal shock</p> <p>Preheating condition</p> <table border="1" style="width: 100%; border-collapse: collapse;"> <thead> <tr> <th>Soldering</th> <th>Case size</th> <th>Temp. (°C)</th> </tr> </thead> <tbody> <tr> <td rowspan="2" style="text-align: center;">Manual soldering</td> <td>C0603(CC0201),C1005(CC0402), C1608(CC0603),C2012(CC0805), C3216(CC1206)</td> <td style="text-align: center;"><math>\Delta T \leq 150</math></td> </tr> <tr> <td>C3225(CC1210), C4532(CC1812), C5750(CC2220)</td> <td style="text-align: center;"><math>\Delta T \leq 130</math></td> </tr> </tbody> </table>	Case size	Temp. (°C)	Duration (sec.)	Wattage (W)	Shape (mm)	C0603(CC0201) C1005(CC0402) C1608(CC0603) C2012(CC0805) C3216(CC1206)	350 max.	3 max.	20 max.	ø3.0 max.	C3225(CC1210) C4532(CC1812) C5750(CC2220)	280 max.	Soldering	Case size	Temp. (°C)	Manual soldering	C0603(CC0201),C1005(CC0402), C1608(CC0603),C2012(CC0805), C3216(CC1206)	$\Delta T \leq 150$	C3225(CC1210), C4532(CC1812), C5750(CC2220)	$\Delta T \leq 130$
Case size	Temp. (°C)	Duration (sec.)	Wattage (W)	Shape (mm)																		
C0603(CC0201) C1005(CC0402) C1608(CC0603) C2012(CC0805) C3216(CC1206)	350 max.	3 max.	20 max.	ø3.0 max.																		
C3225(CC1210) C4532(CC1812) C5750(CC2220)	280 max.																					
Soldering	Case size	Temp. (°C)																				
Manual soldering	C0603(CC0201),C1005(CC0402), C1608(CC0603),C2012(CC0805), C3216(CC1206)	$\Delta T \leq 150$																				
	C3225(CC1210), C4532(CC1812), C5750(CC2220)	$\Delta T \leq 130$																				

No.	Process	Condition
7	Cleaning	<p>1) If an unsuitable cleaning fluid is used, flux residue or some foreign articles may stick to chip capacitors surface to deteriorate especially the insulation resistance.</p> <p>2) If cleaning condition is not suitable, it may damage the chip capacitors.</p> <p>2)-1. Insufficient washing</p> <p>(1) Terminal electrodes may corrode by Halogen in the flux.</p> <p>(2) Halogen in the flux may adhere on the surface of capacitors, and lower the insulation resistance.</p> <p>(3) Water soluble flux has higher tendency to have above mentioned problems (1) and (2).</p> <p>2)-2. Excessive washing</p> <p>When ultrasonic cleaning is used, excessively high ultrasonic energy output can affect the connection between the ceramic chip capacitor's body and the terminal electrode. To avoid this, following is the recommended condition.</p> <p style="text-align: center;">Power : 20 W/l max. Frequency : 40 kHz max. Washing time : 5 minutes max.</p> <p>2)-3. If the cleaning fluid is contaminated, density of Halogen increases, and it may bring the same result as insufficient cleaning.</p>
8	Coating and molding of the P.C.board	<p>1) When the P.C.board is coated, please verify the quality influence on the product.</p> <p>2) Please verify carefully that there is no harmful decomposing or reaction gas emission during curing which may damage the chip capacitors.</p> <p>3) Please verify the curing temperature.</p>

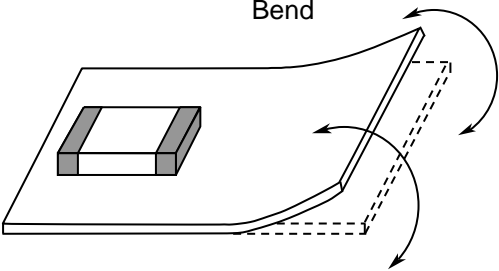
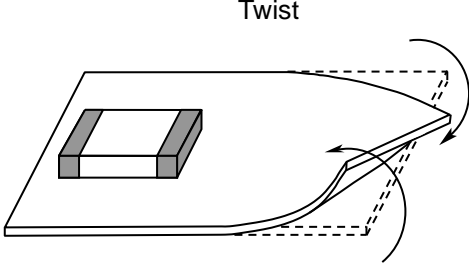
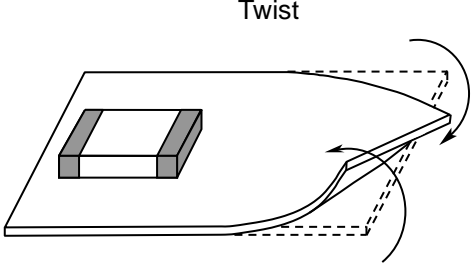
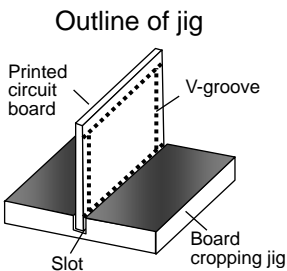
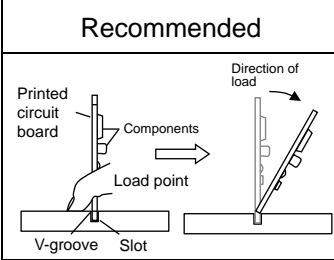
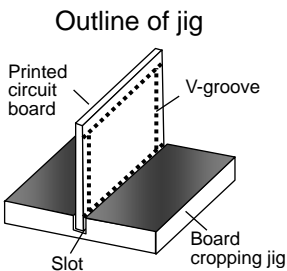
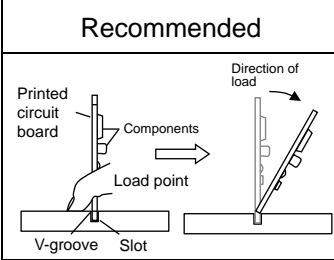
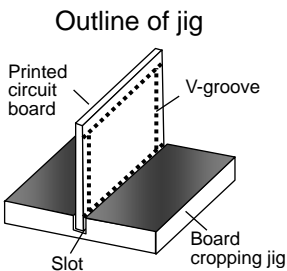
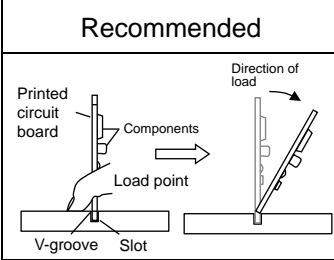
No.	Process	Condition				
9	Handling after chip mounted ⚠ Caution	<p>1) Please pay attention not to bend or distort the P.C.board after soldering in handling otherwise the chip capacitors may crack.</p> <div style="display: flex; justify-content: space-around; align-items: center;"> <div style="text-align: center;"> <p>Bend</p>  </div> <div style="text-align: center;"> <p>Twist</p>  </div> </div> <p>2) Printed circuit board cropping should not be carried out by hand, but by using the proper tooling. Printed circuit board cropping should be carried out using a board cropping jig as shown in the following figure or a board cropping apparatus to prevent inducing mechanical stress on the board.</p> <p>(1) Example of a board cropping jig</p> <p>Recommended example: The board should be pushed from the back side, close to the cropping jig so that the board is not bent and the stress applied to the capacitor is compressive.</p> <p>Unrecommended example: If the pushing point is far from the cropping jig and the pushing direction is from the front side of the board, large tensile stress is applied to the capacitor, which may cause cracks.</p> <div style="display: flex; justify-content: space-around; align-items: center;"> <div style="text-align: center;"> <p>Outline of jig</p>  </div> <table border="1" style="width: 100%; border-collapse: collapse;"> <thead> <tr> <th style="width: 50%; text-align: center;">Recommended</th> <th style="width: 50%; text-align: center;">Unrecommended</th> </tr> </thead> <tbody> <tr> <td style="text-align: center;">  </td> <td style="text-align: center;">  </td> </tr> </tbody> </table> </div>	Recommended	Unrecommended		
Recommended	Unrecommended					
						

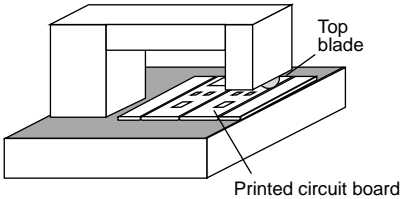
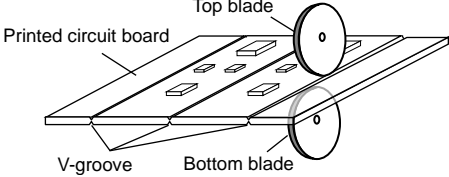
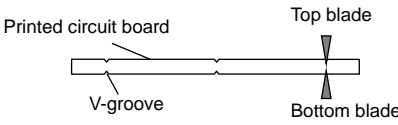
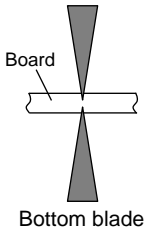
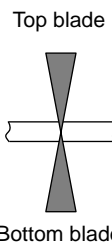
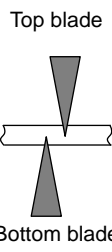
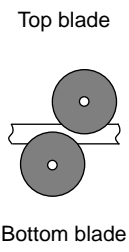
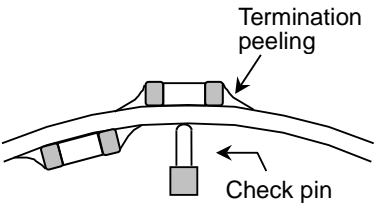
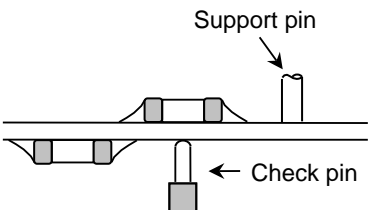
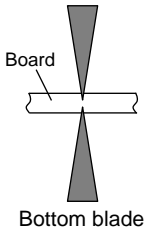
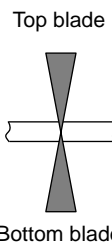
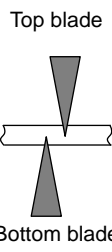
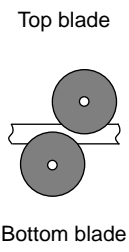
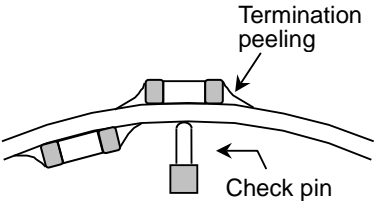
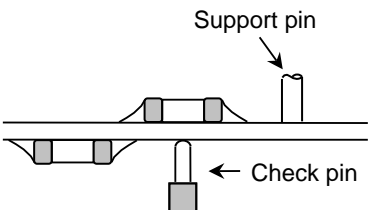
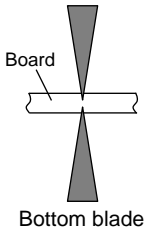
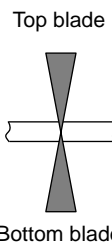
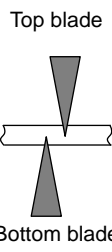
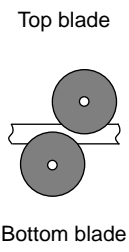
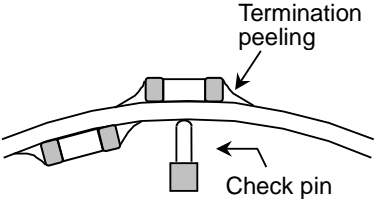
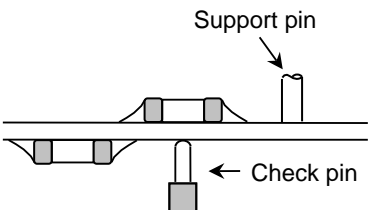
No.	Process	Condition																		
9	Handling after chip mounted  Caution	<p>(2) Example of a board cropping machine</p> <p>An outline of a printed circuit board cropping machine is shown below. The top and bottom blades are aligned with one another along the lines with the V-grooves on printed circuit board when cropping the board.</p> <p>Unrecommended example: Misalignment of blade position between top and bottom, right and left, or front and rear blades may cause a crack in the capacitor.</p> <div style="display: flex; justify-content: space-around;"> <div data-bbox="564 506 967 770"> <p>Outline of machine</p>  </div> <div data-bbox="967 506 1417 748"> <p>Principle of operation</p>  </div> </div> <div style="text-align: center; margin-top: 10px;"> <p>Cross-section diagram</p>  </div> <table border="1" style="width: 100%; text-align: center; margin-top: 20px;"> <thead> <tr> <th data-bbox="646 985 826 1070">Recommended</th> <th colspan="3" data-bbox="826 985 1358 1070">Unrecommended</th> </tr> <tr> <th data-bbox="646 1070 826 1115"></th> <th data-bbox="826 1070 1002 1115">Top-bottom misalignment</th> <th data-bbox="1002 1070 1171 1115">Left-right misalignment</th> <th data-bbox="1171 1070 1358 1115">Front-rear misalignment</th> </tr> </thead> <tbody> <tr> <td data-bbox="646 1115 826 1413">  </td> <td data-bbox="826 1115 1002 1413">  </td> <td data-bbox="1002 1115 1171 1413">  </td> <td data-bbox="1171 1115 1358 1413">  </td> </tr> </tbody> </table> <p>3) When functional check of the P.C. board is performed, check pin pressure tends to be adjusted higher for fear of loose contact. But if the pressure is excessive and bend the P.C. board, it may crack the chip capacitors or peel the terminations off. Please adjust the check pins not to bend the P.C. board.</p> <table border="1" style="width: 100%; text-align: center; margin-top: 20px;"> <thead> <tr> <th data-bbox="478 1657 619 1720">Item</th> <th data-bbox="619 1657 1034 1720">Not recommended</th> <th data-bbox="1034 1657 1437 1720">Recommended</th> </tr> </thead> <tbody> <tr> <td data-bbox="478 1720 619 1951">Board bending</td> <td data-bbox="619 1720 1034 1951">  </td> <td data-bbox="1034 1720 1437 1951">  </td> </tr> </tbody> </table>	Recommended	Unrecommended				Top-bottom misalignment	Left-right misalignment	Front-rear misalignment					Item	Not recommended	Recommended	Board bending		
Recommended	Unrecommended																			
	Top-bottom misalignment	Left-right misalignment	Front-rear misalignment																	
																				
Item	Not recommended	Recommended																		
Board bending																				

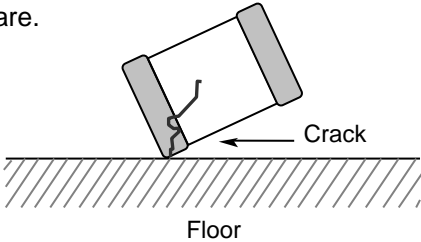
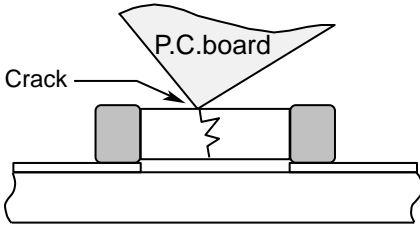
No.	Process	Condition
10	Handling of loose chip capacitors	<p>1) If dropped the chip capacitors may crack. Once dropped do not use it. Especially, the large case sized chip capacitors are tendency to have cracks easily, so please handle with care.</p>  <p>2) Piling the P.C.board after mounting for storage or handling, the corner of the P.C. board may hit the chip capacitors of another board to cause crack.</p> 
11	Capacitance aging	The capacitors (Class 2) have aging in the capacitance. They may not be used in precision time constant circuit. In case of the time constant circuit, the evaluation should be done well.
12	Estimated life and estimated failure rate of capacitors	<p>As per the estimated life and the estimated failure rate depend on the temperature and the voltage. This can be calculated by the equation described in JEITA RCR-2335C Annex F (Informative) Calculation of the estimated lifetime and the estimated failure rate ( Voltage acceleration coefficient : 3 multiplication rule, Temperature acceleration coefficient : 10°C rule)</p> <p>The failure rate can be decreased by reducing the temperature and the voltage but they will not be guaranteed.</p>

No.	Process	Condition
13	Caution during operation of equipment	<p>1) A capacitor shall not be touched directly with bare hands during operation in order to avoid electric shock. Electric energy held by the capacitor may be discharged through the human body when touched with a bare hand. Even when the equipment is off, a capacitor may stay charged. The capacitor should be handled after being completely discharged using a resistor.</p> <p>2) The terminals of a capacitor shall not be short-circuited by any accidental contact with a conductive object. A capacitor shall not be exposed to a conductive liquid such as an acid or alkali solution. A conductive object or liquid, such as acid and alkali, between the terminals may lead to the breakdown of a capacitor due to short circuit.</p> <p>3) Confirm that the environment to which the equipment will be exposed during transportation and operation meets the specified conditions. Do not to use the equipment in the following environments.</p> <p>(1) Environment where a capacitor is splattered with water or oil  (2) Environment where a capacitor is exposed to direct sunlight  (3) Environment where a capacitor is exposed to Ozone, ultraviolet rays or radiation  (4) Environment where a capacitor exposed to corrosive gas(e.g. hydrogen sulfide, sulfur dioxide, chlorine. ammonia gas etc.)  (5) Environment where a capacitor exposed to vibration or mechanical shock exceeding the specified limits.  (6) Atmosphere change with causes condensation</p>
14	Others  Caution	<p>The products listed on this specification sheet are intended for use in general electronic equipment (AV equipment, telecommunications equipment, home appliances, amusement equipment, computer equipment, personal equipment, office equipment, measurement equipment, industrial robots) under a normal operation and use condition.</p> <p>The products are not designed or warranted to meet the requirements of the applications listed below, whose performance and/or quality require a more stringent level of safety or reliability, or whose failure, malfunction or trouble could cause serious damage to society, person or property. Please understand that we are not responsible for any damage or liability caused by use of the products in any of the applications below or for any other use exceeding the range or conditions set forth in this specification sheet. If you intend to use the products in the applications listed below or if you have special requirements exceeding the range or conditions set forth in this specification, please contact us.</p> <p>(1) Aerospace/Aviation equipment  (2) Transportation equipment (cars, electric trains, ships, etc.)  (3) Medical equipment (Excepting Pharmaceutical Affairs Law classification Class1, 2)  (4) Power-generation control equipment  (5) Atomic energy-related equipment  (6) Seabed equipment  (7) Transportation control equipment  (8) Public information-processing equipment  (9) Military equipment  (10) Electric heating apparatus, burning equipment  (11) Disaster prevention/crime prevention equipment  (12) Safety equipment  (13) Other applications that are not considered general-purpose applications</p> <p>When designing your equipment even for general-purpose applications, you are kindly requested to take into consideration securing protection circuit/device or providing backup circuits in your equipment.</p>

## 13. TAPE PACKAGING SPECIFICATION

### 1. CONSTRUCTION AND DIMENSION OF TAPING

#### 1-1. Dimensions of carrier tape

Dimensions of paper tape shall be according to Appendix 3, 4, 5.

Dimensions of plastic tape shall be according to Appendix 6, 7.

#### 1-2. Bulk part and leader of taping

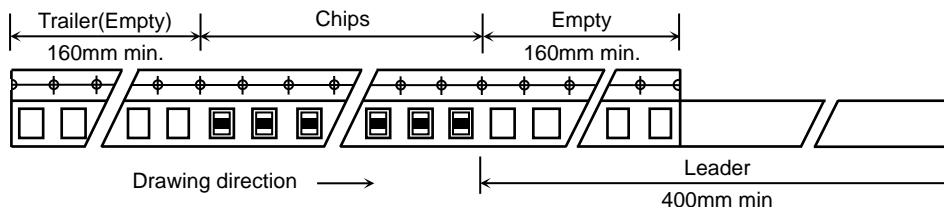

#### 1-3. Dimensions of reel

Dimensions of  $\varnothing 178$  reel shall be according to Appendix 8, 9.

Dimensions of  $\varnothing 330$  reel shall be according to Appendix 10, 11.

#### 1-4. Structure of taping

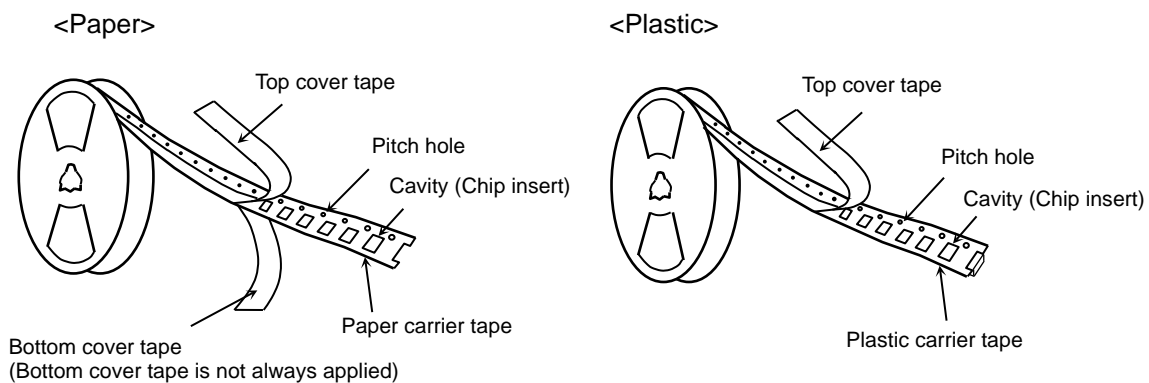

### 2. CHIP QUANTITY

Please refer to detail page on TDK web.



### 3. PERFORMANCE SPECIFICATIONS

#### 3-1. Fixing peeling strength (top tape)

$$0.05\text{N} < \text{Peeling strength} < 0.7\text{N}$$

<Paper>

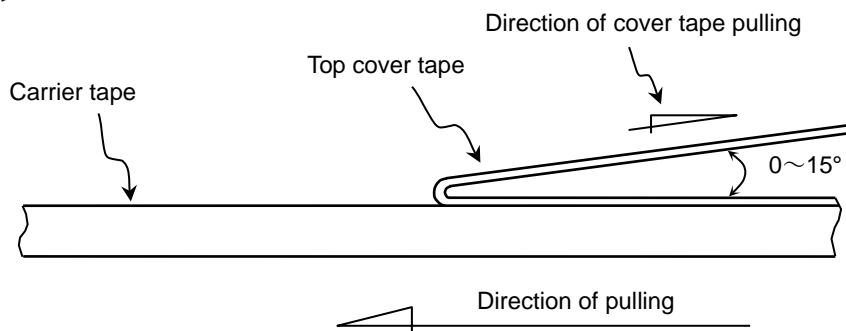

[ Paper tape should not adhere to top cover tape when pull the cover tape. ]

<Plastic>

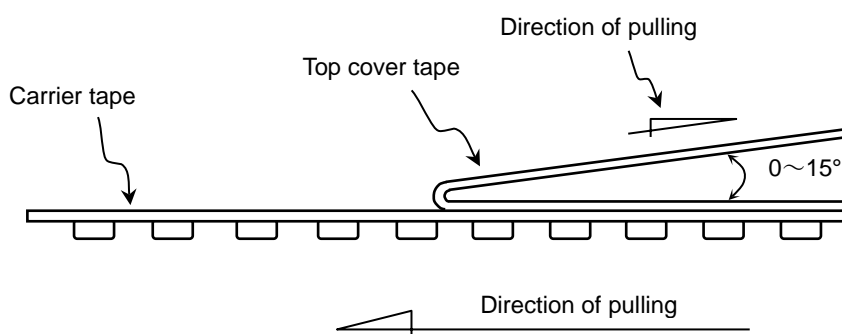

3-2. Carrier tape shall be flexible enough to be wound around a minimum radius of 30mm with components in tape.

3-3. The missing of components shall be less than 0.1%

3-4. Components shall not stick to fixing tape.

3-5. When removing the cover tape, there shall not be difficulties by unfitting clearance gap, burrs and crushes of cavities. Also the sprocket holes shall not be covered by absorbing dust into the suction nozzle.

### Appendix 3

#### Paper Tape

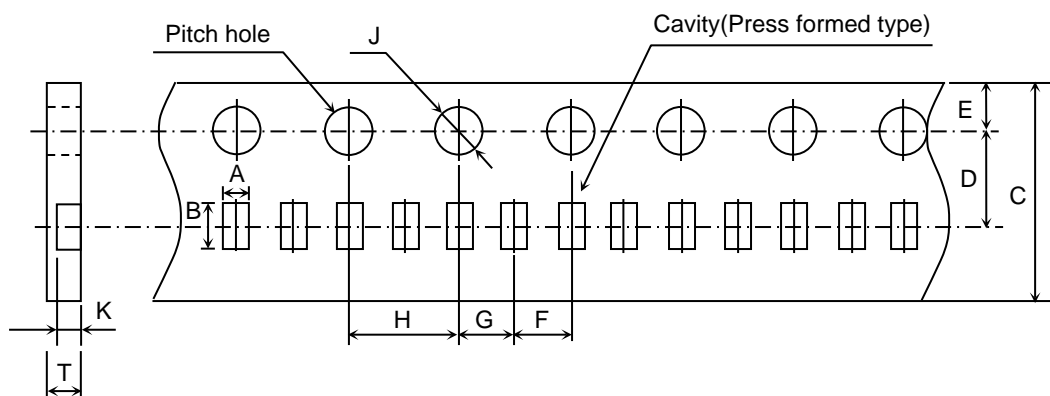

(Unit : mm)

Symbol Case size	A	B	C	D	E	F
C0603 (CC0201)	( 0.38 ) *( 0.40 )	( 0.68 ) *( 0.70 )	8.00±0.30	3.50±0.05	1.75±0.10	2.00±0.05

Symbol Case size	G	H	J	K	T
C0603 (CC0201)	2.00±0.05	4.00±0.10	∅ 1.50 <sup>+0.10</sup> <sub>0</sub>	0.35±0.02 *0.38±0.02	0.40 min.

( ) Reference value.

\* Applied to thickness, 0.30±0.05mm products.

### Appendix 4

#### Paper Tape

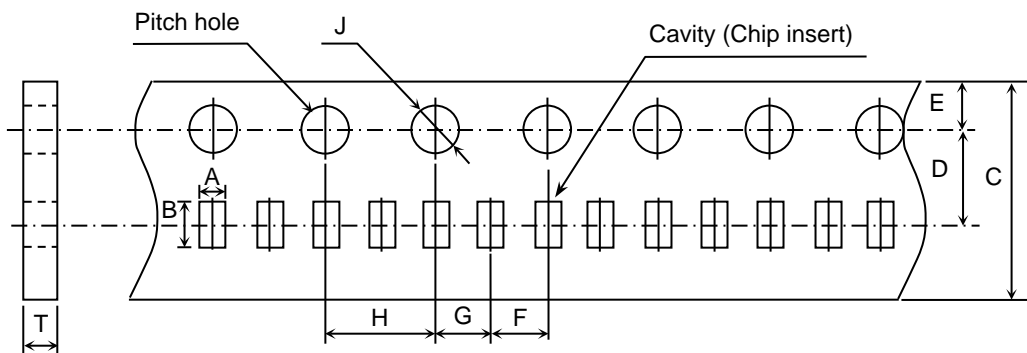

(Unit : mm)

Symbol Case size	A	B	C	D	E	F
C1005 [CC0402]	( 0.65 ) *( 0.73 )	( 1.15 ) *( 1.23 )	8.00 ± 0.30	3.50 ± 0.05	1.75 ± 0.10	2.00 ± 0.05

Symbol Case size	G	H	J	T
C1005 [CC0402]	2.00 ± 0.05	4.00 ± 0.10	∅ 1.50 <sup>+0.10</sup> <sub>0</sub>	0.60±0.05 * 0.68±0.05

( ) Reference value.

\* Applied to thickness, 0.50±0.10mm and 0.50 +0.15,-0.10mm products.

## Appendix 5

### Paper Tape

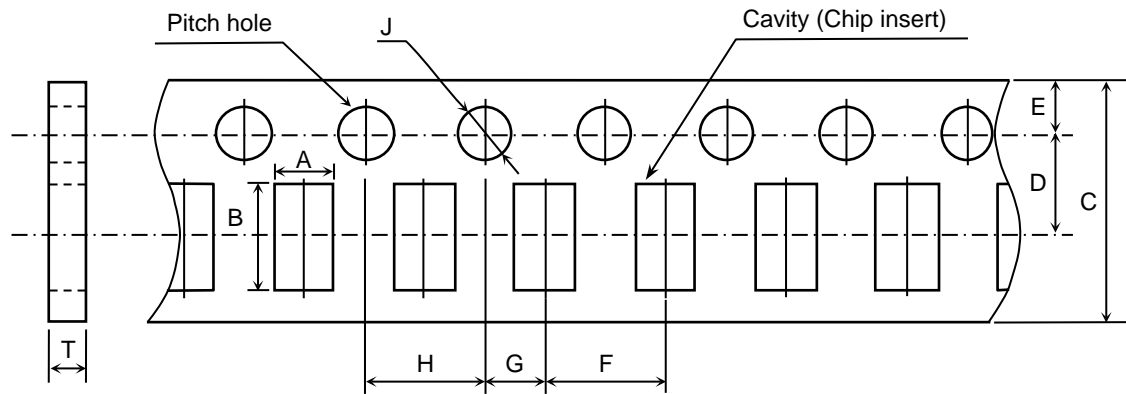

(Unit : mm)

Symbol	A	B	C	D	E	F
Case size						
C1608 [CC0603]	( 1.10 )	( 1.90 )	8.00 ± 0.30	3.50 ± 0.05	1.75 ± 0.10	4.00 ± 0.10
C2012 [CC0805]	( 1.50 )	( 2.30 )				
C3216 [CC1206]	( 1.90 )	( 3.50 )				
Symbol	G	H	J	T		
Case size						
C1608 [CC0603]	2.00 ± 0.05	4.00 ± 0.10	∅ 1.50 $\begin{matrix} +0.10 \\ 0 \end{matrix}$	1.20 max.		
C2012 [CC0805]						
C3216 [CC1206]						

( ) Reference value.

## Appendix 6

### Plastic Tape

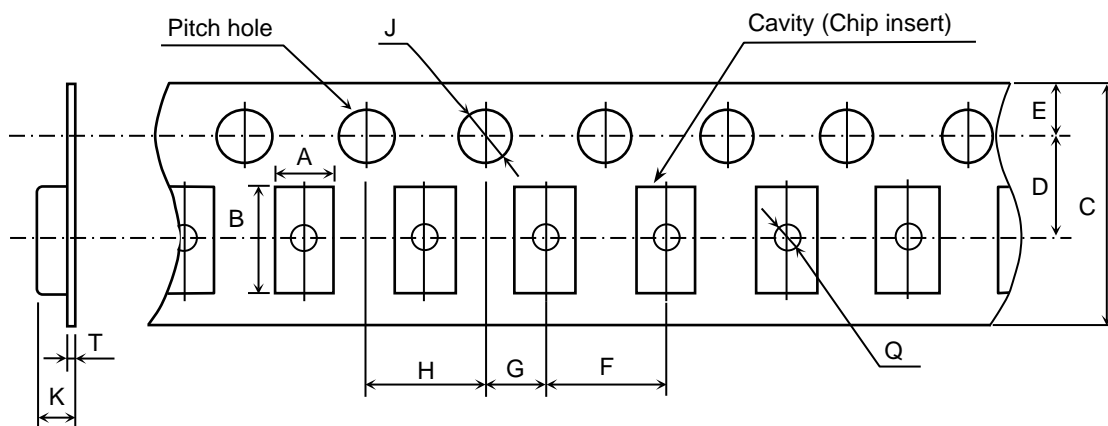

(Unit : mm)

Symbol	A	B	C	D	E	F
Case size						
C2012 [CC0805]	( 1.50 )	( 2.30 )	8.00 ± 0.30	3.50 ± 0.05	1.75 ± 0.10	4.00 ± 0.10
C3216 [CC1206]	( 1.90 )	( 3.50 )				
C3225 [CC1210]	( 2.90 )	( 3.60 )				
			*12.00 ± 0.30	*5.50 ± 0.05		
Symbol	G	H	J	K	T	Q
Case size						
C2012 [CC0805]	2.00 ± 0.05	4.00 ± 0.10	∅ 1.50 $\begin{smallmatrix} +0.10 \\ 0 \end{smallmatrix}$	2.50 max.	0.60 max.	∅ 0.50 min.
C3216 [CC1206]						
C3225 [CC1210]				3.40 max.		

( ) Reference value.

\* Applied to thickness, 2.5mm products.

Exceptionally no hole in the cavity is applied. Please inquire if hole in cavity is mandatory.

## Appendix 7

### Plastic Tape

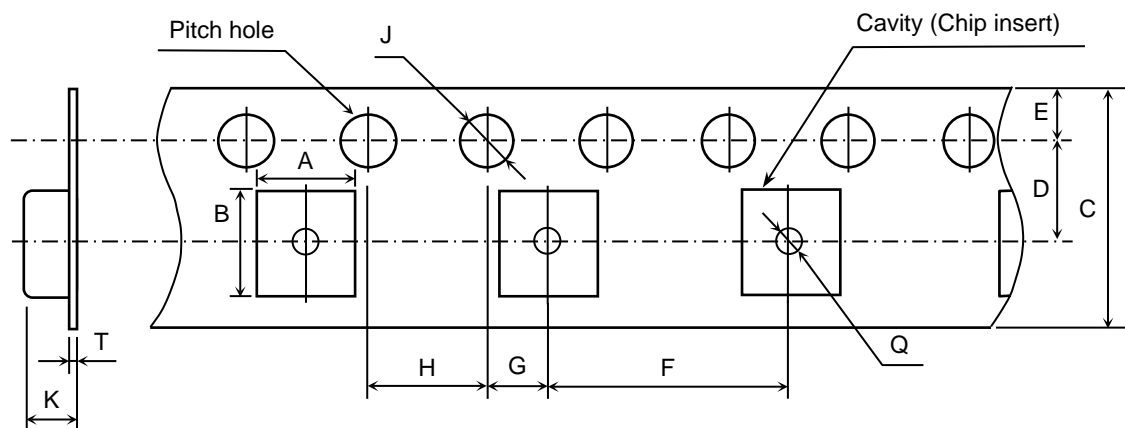

(Unit : mm)

Symbol	A	B	C	D	E	F
Case size						
C4532 [CC1812]	( 3.60 )	( 4.90 )	12.00 ± 0.30	5.50 ± 0.05	1.75 ± 0.10	8.00 ± 0.10
C5750 [CC2220]	( 5.40 )	( 6.10 )				
Symbol	G	H	J	K	T	Q
Case size						
C4532 [CC1812]	2.00 ± 0.05	4.00 ± 0.10	∅ 1.50 $\begin{matrix} +0.10 \\ 0 \end{matrix}$	6.50 max.	0.60 max.	∅ 1.50 min.
C5750 [CC2220]						

( ) Reference value.

Exceptionally no hole in the cavity is applied. Please inquire if hole in cavity is mandatory.

### Appendix 8

Dimensions of reel (Material : Polystyrene)  
C0603, C1005, C1608, C2012, C3216, C3225

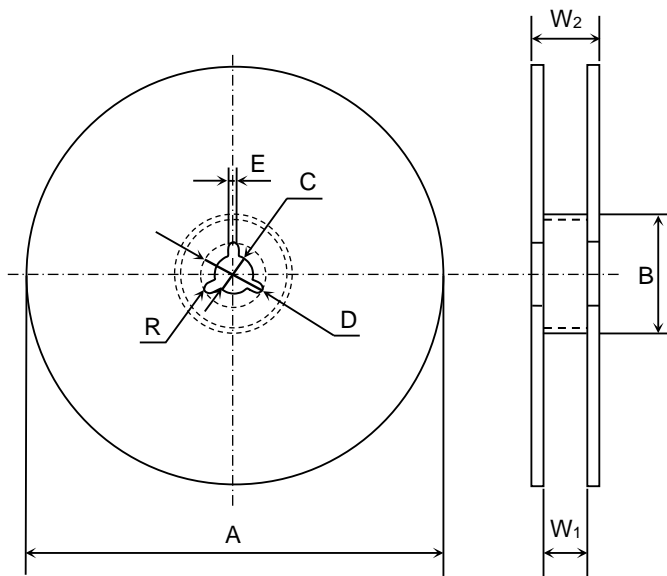

(Unit : mm)

Symbol	A	B	C	D	E	W <sub>1</sub>
Dimension	∅ 178 ± 2.0	∅ 60 ± 2.0	∅ 13 ± 0.5	∅ 21 ± 0.8	2.0 ± 0.5	9.0 ± 0.3
Symbol	W <sub>2</sub>	R				
Dimension	13.0 ± 1.4	1.0				

### Appendix 9

Dimensions of reel (Material : Polystyrene)  
C3225(2.5mm thickness products), C4532, C5750

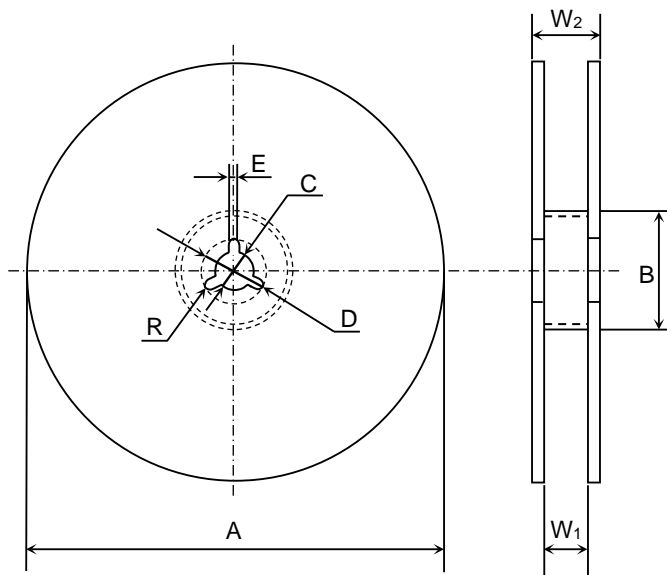

(Unit : mm)

Symbol	A	B	C	D	E	W <sub>1</sub>
Dimension	∅ 178 ± 2.0	∅ 60 ± 2.0	∅ 13 ± 0.5	∅ 21 ± 0.8	2.0 ± 0.5	13.0 ± 0.3
Symbol	W <sub>2</sub>	R				
Dimension	17.0 ± 1.4	1.0				

## Appendix 10

Dimensions of reel (Material : Polystyrene)  
C0603, C1005, C1608, C2012, C3216, C3225

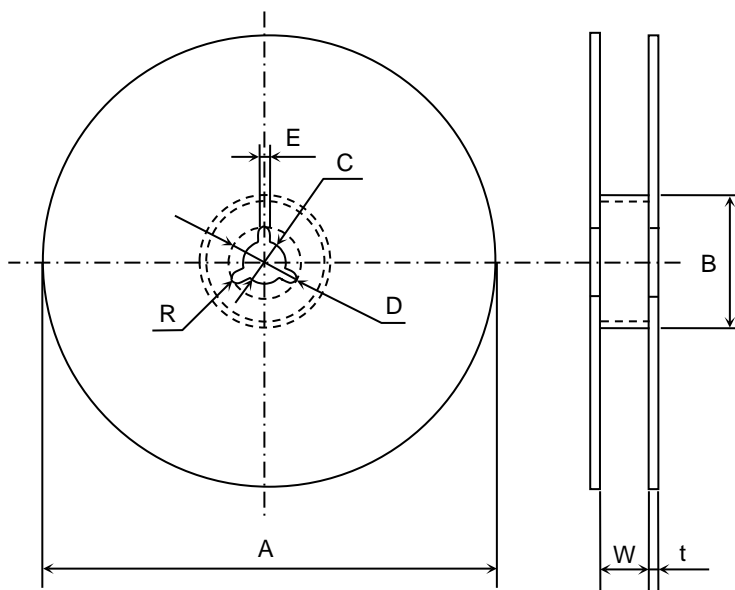

(Unit : mm)

Symbol	A	B	C	D	E	W
Dimension	$\varnothing 382$ max. (Nominal $\varnothing 330$ )	$\varnothing 50$ min.	$\varnothing 13 \pm 0.5$	$\varnothing 21 \pm 0.8$	$2.0 \pm 0.5$	$10.0 \pm 1.5$
Symbol	t	R				
Dimension	$2.0 \pm 0.5$	1.0				

## Appendix 11

Dimensions of reel (Material : Polystyrene)  
C3225(2.5mm thickness products), C4532, C5750

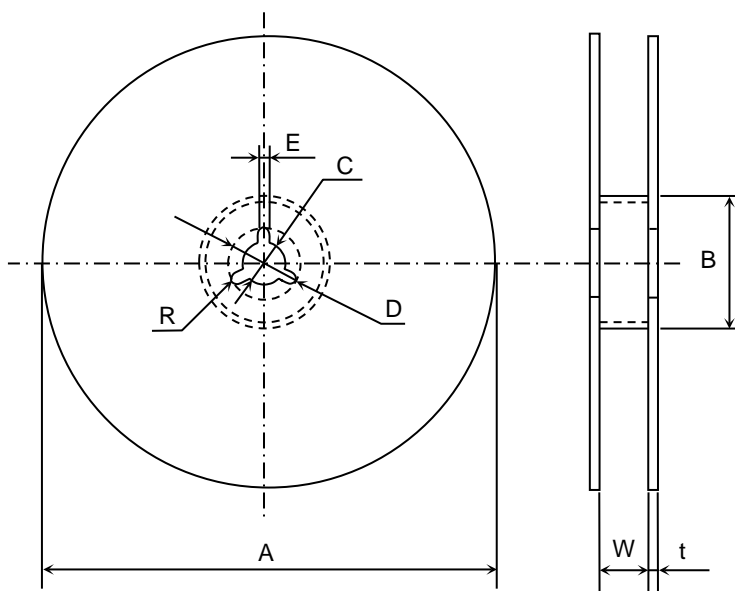

(Unit : mm)

Symbol	A	B	C	D	E	W
Dimension	$\varnothing 382$ max. (Nominal $\varnothing 330$ )	$\varnothing 50$ min.	$\varnothing 13 \pm 0.5$	$\varnothing 21 \pm 0.8$	$2.0 \pm 0.5$	$14.0 \pm 1.5$
Symbol	t	R				
Dimension	$2.0 \pm 0.5$	1.0				