

HLAL Series

DIN41612 C Type Female

Drawing NO. : DIN075

UNIT:mm

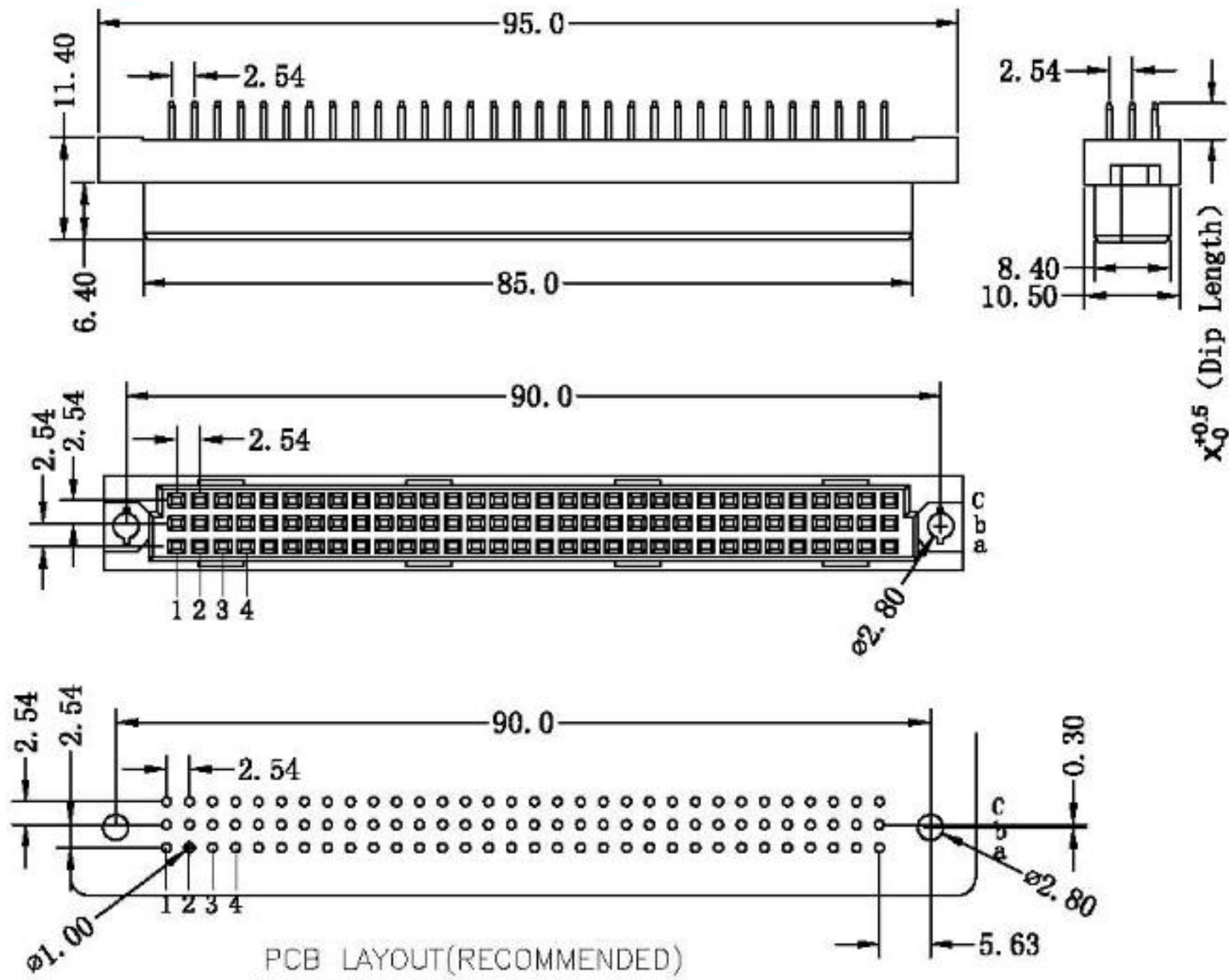

MATERIAL:

Contacts: Brass
Housing: PBT UL 94V-0

ELECTRICAL CHARACTERISTICS:

Current Rating: 2 A
Dielectric Withstanding Voltage: AC 1000V
Insulator Resistance: 1000 MΩ min
Contact Resistance: 30 mΩ max
Operating Temperature: -55° C ~ +105° C

Pitch	Position	Rows with Contacts	Contact Arrange	Length					
				X	1	2	3	4	5
2.54mm	96	a b c							
	64	a b -							
	64	a - c							
	32	a - -							
5.08mm	48	a b c							
	32	a b -							
	32	a - c							
	16	a - -							

ORDERING INFORMATION

Series N.O	Pitch(mm)	Contact Type	Position	Contact length(mm)	Contact Plating	Glod Plating	Dip Type
HLAL-	*	2	*	*	*	*	D
DIN41612 C Type	1: 2.54 2: 5.08	2:Female	96 64 48 32 16	1: 4.0 2: 13.0 3: 15.0 4: 17.0 5: 25.0	C: Dip Tin Contact Gold G: Glod	00: G/F 02: 2u" 03: 3u" 05: 5u" 10: 10u" 15:15u" 30: 30u"	Blank: Dip

Tel: 86-10-57891098 MP :86-13001179378 or 13146881693

Mail: info@hlpint.com or lucyliu0807 @163.com